

Draka UC Connectivity

Draka 1U 19" Sliding Patch Panel 12 Way Multimode OM5 - 6 LC Duplex Adaptors (12 Fibre)

Part Number – YPPBP03339



Overview

- Multimode and Singlemode options available
- Choice of port density
- Adjustable fixing arms
- Multiple cable gland entry ports on rear
- Sliding drawer with quick release latches
- Screen printed for easy labelling
- Recessed adaptors provide improved fibre management

Product Description

The Draka range of LC patch panels are a sliding drawer mechanism, suitable for either direct termination or splicing of up to 48 fibres in 1U of rack space. Each panel is manufactured to a high-quality finish with no sharp edges to provide a strong and durable unit. The sliding tray is locked in place with two simple plastic latches, when fully extended the tray is designed to lower to 45° or move the sliding tray to the side and it will lock to lower only 10°. This provides the perfect working platform for simple installation or easy maintenance and access even after the panel is installed in the rack.

Each panel is pre-loaded with the required number of adaptors with splice cassette and all required accessories to complete the installation, this includes (Splice protectors, Laser warning label, 2x20mm 1x25mm Cable Glands, Earth Bonding Kit, Cage Nuts).

Product Specification

Suitable for number of fibre cores	12
Loaded with number of adaptors	6
Fibre Type	Multimode OM5
Type of Adaptor	LC Duplex – Lime Green

© PRYSMIAN GROUP 2020, All Rights Reserved

All sizes and values without tolerances are reference values. Specifications are for product as supplied by Prysmian: any modification or alteration afterwards of product may give different result.

The information contained within this document must not be copied, reprinted or reproduced in any form, either wholly or in part, without the written consent of Prysmian. The information is believed to be correct at the time of issue. Prysmian reserves the right to amend this specification without prior notice. This specification is not contractually valid unless specifically authorised by Prysmian.

Draka UC Connectivity

Colour	Black
Mounting Type	1U 19"
Height x Width x Depth	1U 44.4mm x 482mm x 205mm
Net Weight	2.4kg
Packaged Weight	3kg
Packaged Dimensions	(H) 50mm x (W) 530mm x (D) 260mm
IP Rating	IP20
Mounting Adjustment Range	50mm
Cable Entry 20mm	2
Cable Entry 25mm	1
Material Thickness	1.2mm
Material Coating	Electrostatic Powder Coating
Colour	Black RAL 9004
Operating Temperature	-40°C to +60°C

© PRYSMIAN GROUP 2020, All Rights Reserved

All sizes and values without tolerances are reference values. Specifications are for product as supplied by Prysmian: any modification or alteration afterwards of product may give different result.

The information contained within this document must not be copied, reprinted or reproduced in any form, either wholly or in part, without the written consent of Prysmian. The information is believed to be correct at the time of issue. Prysmian reserves the right to amend this specification without prior notice. This specification is not contractually valid unless specifically authorised by Prysmian.

Standards Complied

ANSI/EIA-310-D	Electronic Industries Association standard for horizontal spacing, vertical hole spacing, rack opening and front panel width
IEC 60297-3-100	Mechanical structures for electronic equipment - Dimensions of mechanical structures of the 482,6 mm (19 in) series - Part 3-100: Basic dimensions of front panels, subracks, chassis, racks and cabinets
BS EN 50310:2016	Telecommunications bonding networks for buildings and other structures
IEC 61300-2-22	Fibre optic interconnecting devices and passive components - Basic test and measurement procedures Change of temperature
IEC 61300-3-4:2012	Fibre optic interconnecting devices and passive components - Basic test and measurement procedures Attenuation
IEC 61300-2-2	Fibre optic interconnecting devices and passive components - Basic test and measurement procedures Mating durability
RoHS	Restriction of Hazardous Substances Directive 2011/65/EU & 2015/863/EU
REACH	Regulation (EC) No 1907/2006 - Registration, Evaluation, Authorisation and Restriction of Chemicals EC1907/2006

© PRYSMIAN GROUP 2020, All Rights Reserved

All sizes and values without tolerances are reference values. Specifications are for product as supplied by Prysmian: any modification or alteration afterwards of product may give different result.

The information contained within this document must not be copied, reprinted or reproduced in any form, either wholly or in part, without the written consent of Prysmian. The information is believed to be correct at the time of issue. Prysmian reserves the right to amend this specification without prior notice. This specification is not contractually valid unless specifically authorised by Prysmian.

Draka UC Connectivity

Product Drawing

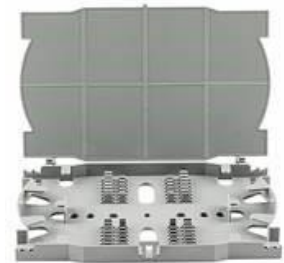
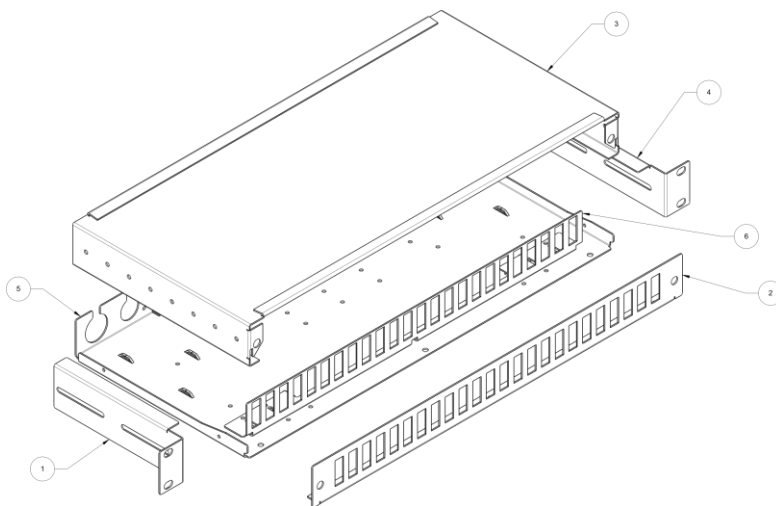
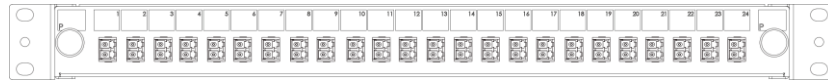

© PRYSMIAN GROUP 2020, All Rights Reserved

All sizes and values without tolerances are reference values. Specifications are for product as supplied by Prysmian: any modification or alteration afterwards of product may give different result.

The information contained within this document must not be copied, reprinted or reproduced in any form, either wholly or in part, without the written consent of Prysmian. The information is believed to be correct at the time of issue. Prysmian reserves the right to amend this specification without prior notice. This specification is not contractually valid unless specifically authorised by Prysmian.