

# Optical Fibre Ducting - Raceway

Solutions, Products & Accessories

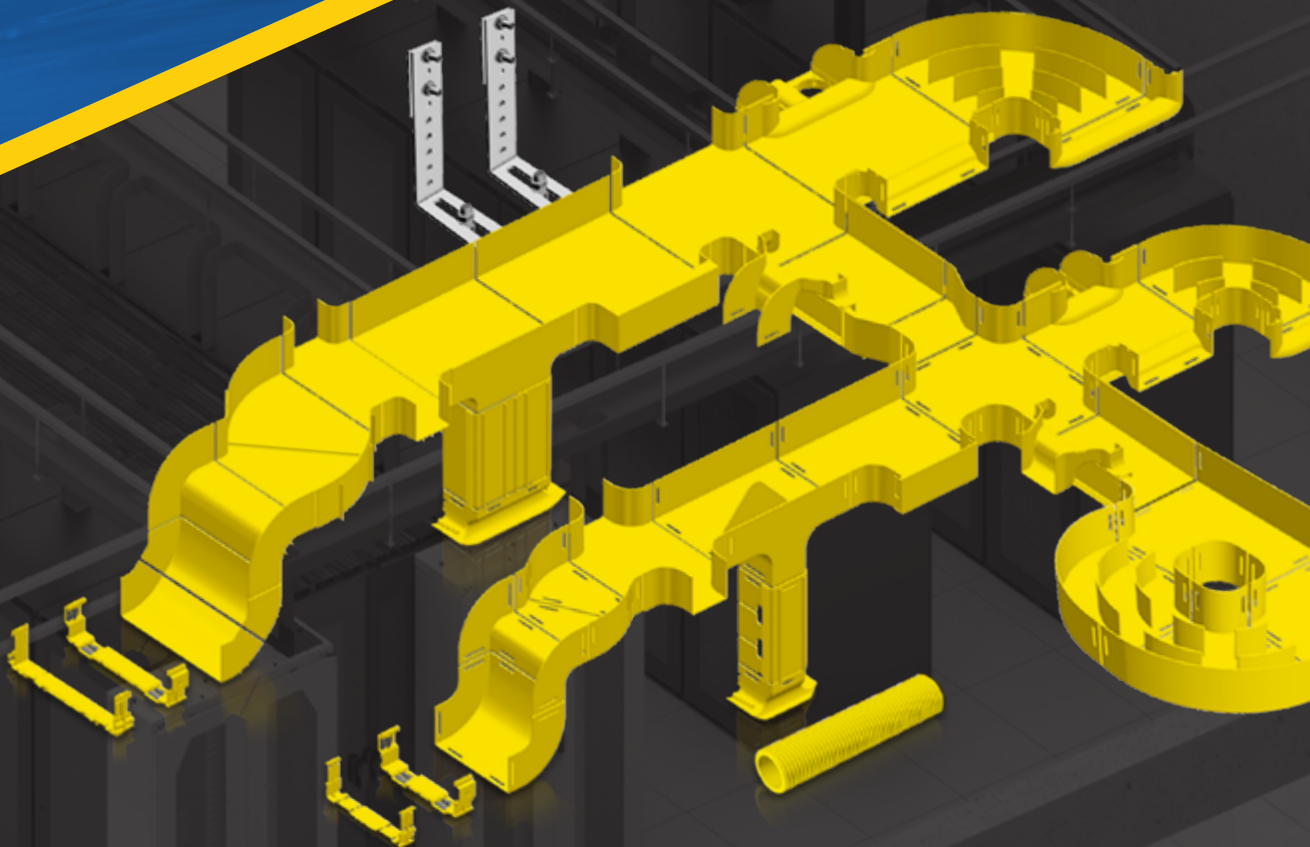

# At Warren & Brown, we listen, we respect and we deliver.

**Warren & Brown provides leading optical fibre and copper cabling products and solutions for various markets.**

Our designers and engineers are constantly looking for ways to improve customer offerings and by working closely with our customers, the company is able to achieve continual improvement.

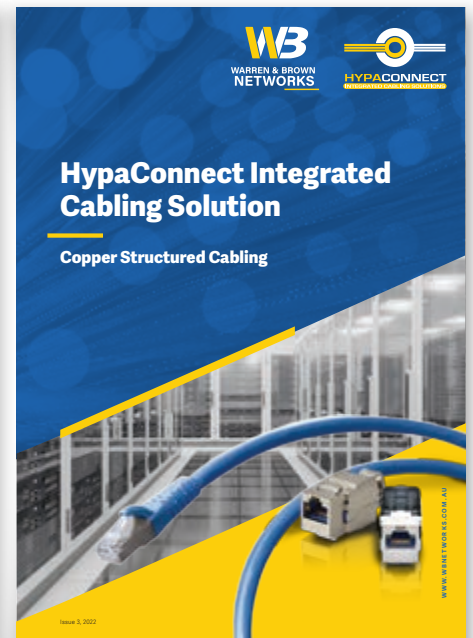

# Why use the WBT Fibre Optic Ducting ~ Raceway System

**WBT's optical fibre ducting raceway is a unique system for routing and protecting fibre optic cords between termination equipment, patch panels and fibre optic splicing frames in telecommunications exchanges and data centres. Easily mounted above equipment racks or below floors, it provides an easily accessible solution to any situation.**

WBT YellowDuct ducting raceway is available in seven sizes. It is most important to select a size that allows for expansion and future additions to the ducting system. All too often cable systems are underspecified in order to reduce installation costs. In this world of the ever increasing need for the storage and processing of data it is a false economy to just specify for existing needs. It is ultimately more cost effective to plan for the future and over specify when it comes to capacity. Cable exit points and take offs also need to be taken into account as these components have different capacity ratings to the main ducting raceway.

WBT components simply snap together or can be joined with "slotless" joiners. Vertical drops can be positioned or added easily by adding a cutout in the horizontal duct raceway with a simple to operate hand tool or by using the express "over the top" drop options requiring no tools.

The unique design of the WBT system protects the fibre from damage and ensures that the bend radius of the cable is not compromised. All components in the WBTs system are manufactured from Noryl, a very strong engineering plastic, which is self-extinguishing and halogen free (certified to UL94V-0 specifications for 100, 220 and 300mm ducting, and to UL94V-1 specifications for 30 and 50mm ducting), which means in the case of a fire, the gases emitted will not cause harm to personnel, buildings or transmission equipment, unlike some other brands of ducting.

WBT fibre optic ducting raceway products are manufactured to the highest quality standards (ISO9001), complying with the stringent requirements of UL2024A & ROHS and carry a 10 year warranty.

## WBT Ducting Raceway items, conform to the following standards and requirements:

- ISO 9001 Certified Quality Management System by BSI
- Fire retardant plastic, Halogen Free, for 100, 220 and 300mm ducting the rating is UL94V-0, for 30 and 50mm ducting the rating is UL94V-1
- UL2024A standard
- EEU - ROHS requirements
- GR-63 Core Earthquake test compliance

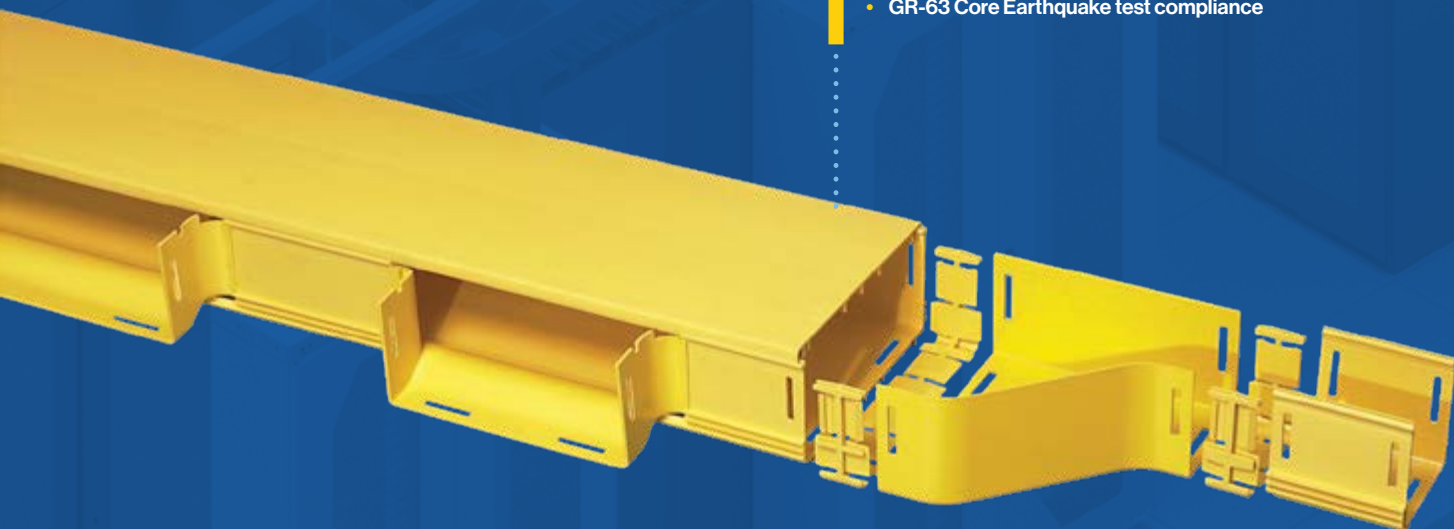

**WBT YellowDuct ducting-raceway** can be mounted from walls, ladder rack, Unistrut™, on raised floor support brackets, on floors, or to the top of equipment racks or frames. **Over 350 individual components are available in 7 different sizes.**

## Contents

<b>Ducting-raceway products</b>	<b>5</b>
600mm x 100mm system	5
Straight duct lengths	5
Joiners	6
Vertical elbows	6
Horizontal elbows	7
Horizontal tees	7
Vertical tees	7
Horizontal crosses	8
Fibre storage loops	8
Adaptors	8
End caps	9
Tubing	9
Reducers	10
Low profile ducting solution	10
<b>Data rack ducting &amp; accessories</b>	<b>11</b>
<b>Drop-off solutions</b>	<b>12</b>
<b>Mounting solutions</b>	<b>17</b>
<b>Tooling components</b>	<b>22</b>

# Which ducting raceway suits your needs

The capacities listed below are recommended to ensure no damage will occur to the cords due to crushing. This is not the number of optical fibre cords that the ducting raceway will accommodate if completely filled.

DUCT SIZE	MILLIMETRES	30 X 30	50 X 50	100 X 50	100 X 100	220 X 100	300 X 100	600 X 100
	INCHES	1.25 x 1.25	2 x 2	4 x 2	4 x 4	8 x 4	12 x 4	24 x 4
OPTICAL CABLE SIZE/MM		2	2	2	2	2	2	2

## Capacities

STRAIGHT DUCTING RACEWAY	100	280	560	1110	2450	3340	7500
DUCTING RACEWAY WITH RAMP-OFF				670	1470		
VERTICAL TEE-STRAIGHT THROUGH				1110	980		
VERTICAL TEE DOWNSPOUT-DROP OVER THE TOP OUTLET				1110	1100		

CONVOLUTED TUBING	SPLIT 20MM DIA.	38MM DIA.	50MM DIA.	75MM DIA.	50X50 SQUARE
OPTICAL CABLE SIZE/MM	2	2	2	2	2
TUBING CAPACITY	22	125	220	360	280

Note: Calculations are based on half full duct capacity - 50%

## Ducting raceway mounting

WBT YellowDuct ducting raceway can be mounted from walls, ladder rack, unistrut, on raised floor support brackets, on floors, or to the top of equipment racks of frames. Select an appropriate mounting method from the examples shown otherwise you can contact your WBT sales office or distributor for additional mounting options and custom solutions.

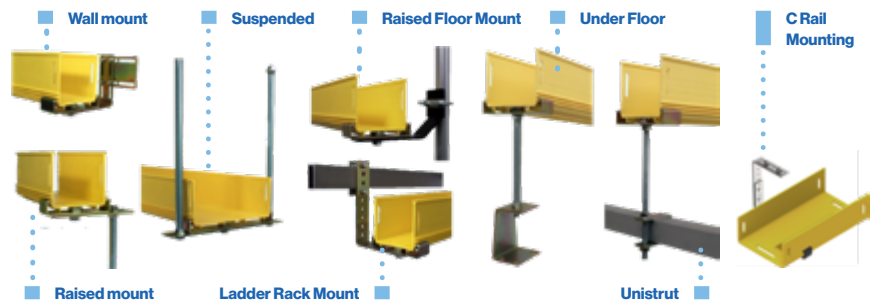

## Cable entry and exits

Select the appropriate drop-off or outlet method from the following examples:

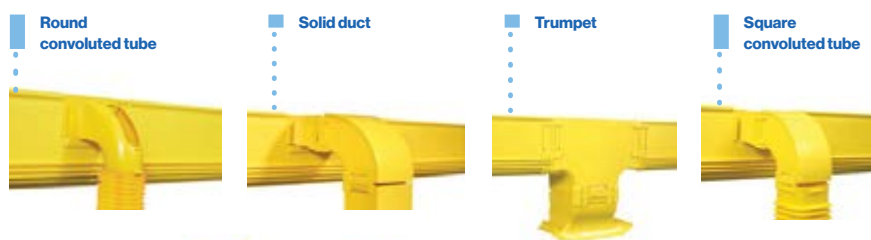

Fibre cords can be simply routed via ramp off into or out of the ducting.

Cords can easily pass through the ducting to the next drop point or exit.

## Colour coding for optimum cable management

### Orange ducting is recommended for highlighting the redundant fibre network

With the ever increasing demand for zero down-time solutions in Data Centres and Telecommunications networks there has been a growing need for redundancy cable systems. To route both operating and redundant optic fibres in the yellow coloured ducting can create problems in identification of the redundant fibre and/or system. As a result there is an obvious need to differentiate between the operating and redundant networks of fibre optic cabling. To minimise the potential for costly mistakes in this area, WBT has introduced orange ducting which is recommended for highlighting the redundant fibre network, thereby improving maintenance efficiency.



### Black ducting is recommended for use with UTP 10 Gigabit copper

Parallel to the redundancy needs, a new issue has arisen in installations. The state-of-the-art 10 Gigabit copper UTP cabling also has very high demands on bend radius. This requires a new approach to the conventional metal cable trays (ladders, baskets, etc.). The conventional metal trays are not designed to provide safe bending radius and as a result WBT has introduced black ducting. Again, this new black ducting has the same unique features and benefits of the yellow and orange ducting and allows clear distinction of the sensitive 10 Gigabit copper UTP cabling from the two Lightpaths optic fibre systems.



*Note: All part numbers listed on the website are for yellow ducting, so when ordering black or orange ducting just add "O" for orange or "B" for black to the end of the relevant part number. However, black and orange are only available in duct sizes 100 x 100mm, 220 x 100mm & 300 x 100mm.*

## Ducting joiner options

The YellowDuct optical fibre ducting raceway system has 2 methods for joining the components together, slotted joiners or slotless joiners.

Slotted joiners require the ducting and components to have slots on the ends so that it can be properly joined by clicking into place. A slotting tool will be required.

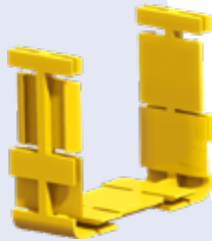

Slotless joiners require no additional tooling or for slots to be made in the side of the duct. They only require a screwdriver for installation to tighten the joiner into place.



**Note: All ducting components and lengths are supplied pre-slotted.**

## Draw a plan

Draw a view plan of the room/area where ducting raceway is required. Include cabinet sizes and positions as well as ladder racks, cable trays or air conditioning ducts. Denote duct size required in each area. Mark ducting raceway support bracket locations. The recommended spacing for mounting brackets is 900mm or 1.2m maximum.

For copper systems use 600mm spacing. Brackets should be mounted close to the joiners if possible. Draw a side view of all areas where the ducting raceway changes level or mounting system needs to change.

**Feel free to get in touch with W&B directly to assist with design and development of a layout.**

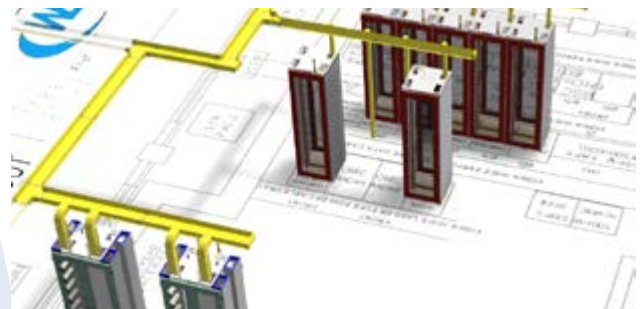

## Material list

List all components required by part number and quantity from the following pages.

*Note: Ensure that all components including joiners, mounting hardware, end caps, convoluted tube etc. are included. We recommend including 10% more joiners and brackets.*

# Ducting raceway products

## 600mm x 100mm system

The 600mm x 100mm (24" x 4") ducting raceway system from WBT provides maximum capacity for routing and protecting optical fibre patch cords. Up to 7500, 2mm patch cords can be routed through the 600mm x 100mm ducting raceway system (50% fill rate), thereby doubling the capacity of the previous largest 300mm x 100mm system.

The 600 x 100mm ducting raceway system is compatible with most other WBT ducting components, including drop-offs, outlets and reducers and is easy to install.

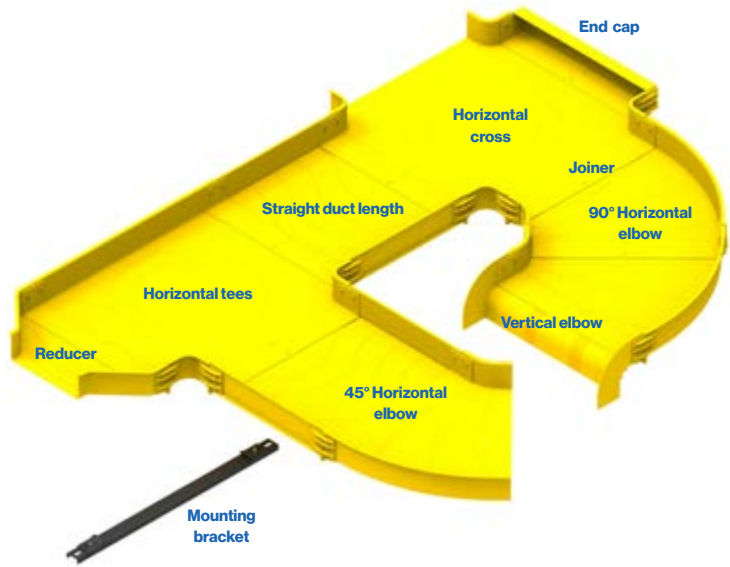

PART NO.	DESCRIPTION
TC1279-406	600mm x 100mm straight duct length - 2 m
TC1279-408	600mm x 100mm to 300mm x 100mm reducer
TC1279-410A	600mm x 100mm joiner
TC1279-411A	600mm x 100mm 90° horizontal elbow
TC1279-412	600mm x 100mm horizontal tee
TC1279-414	600mm x 100mm 45° horizontal elbow
TC1279-425A	600mm x 100mm 90° vertical elbow
TC1279-416	600mm x 100mm horizontal cross
TC1279-435	600mm x 100mm end cap
TC1279-438A	600mm x 100mm duct mounting bracket assembly

## Straight duct lengths

WBT YellowDuct straight duct lengths are available in seven sizes with or without covers. Slotted duct / raceway is available in some sizes for vertical drops or applications inside equipment racks to allow cords to exit through the side of the duct. Some sizes are available with hinged covers (hinges included in pack), or clip on covers.

All duct sizes come in 2m (6' 7") lengths, and where required, are slotted at each end for simply snapping together with an appropriate joiner. Most other ducting raceway brands are only available in 6 foot lengths - 10% shorter than YellowDuct.



SIZE (MM) SIZE (INCHES)	30 X 30 1.25" X 1.25"	50 X 50 2" X 2"	100 X 50 4" X 2"	100 X 100 4" X 4"	220 X 100 8" X 4"	300 X 100 12" X 4"	600 X 100 24" X 4"
Solid duct	TC1279-83	TC1279-81	TC1279-223	TC1279-23	TC1279-21	TC1279-275	TC1279-406
Solid duct & cover	TC1279-83XA	TC1279-81XA	TC1279-223ASN	TC1279-23ASN	TC1279-21ASN	TC1279-275A	N/A
Solid duct & hinged cover	TC1279-83A	TC1279-81A	TC1279-223A	TC1279-23A	TC1279-21A	N/A	N/A
Slotted duct (side exit)	TC1279-83SL	TC1279-81SL	TC1279-223SL	TC1279-23SL	N/A	N/A	N/A
Slotted duct & cover	TC1279-83SLXA	TC1279-81SLXA	TC1279-223SLASN	TC1279-23SLASN	N/A	N/A	N/A
Slotted duct & hinged cover	TC1279-83SLA	TC1279-81SLA	TC1279-223SLXA	TC1279-23SLA	N/A	N/A	N/A

## Joiners

WBT YellowDuct joiners are used to snap together system components and straight ducting raceway. They simply snap into the slots in the end of each piece to be joined.

“Slotless” joiners are available in sizes from 100mm x 50mm upwards and will join the ducting raceway components with or without joining slots. In the case of locking/unlocking joiners into place, WBT’s 62x41 Slotless Joiner can be utilised.

Note: For straight ducting raceway that has been cut to length, new slots need to be made with a suitable size slotting tool when using slotted joiners.

All components (tees, elbows, etc) come preslotted to aid speedy installation.

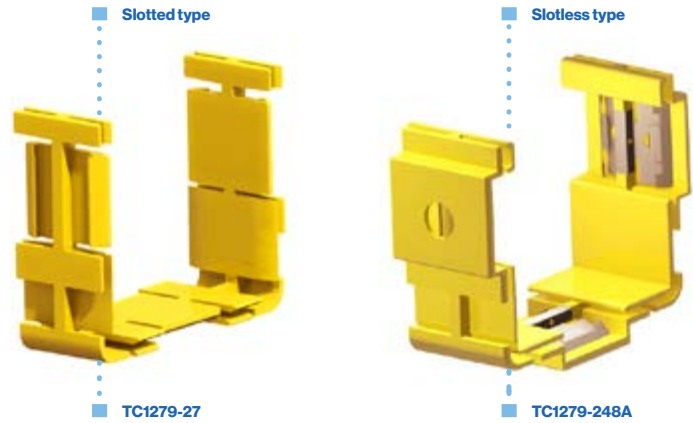

SIZE (MM) SIZE (INCHES)	30 X 30 1.25" X 1.25"	50 X 50 2" X 2"	100 X 50 4" X 2"	100 X 100 4" X 4"	220 X 100 8" X 4"	300 X 100 12" X 4"	600 X 100 24" X 4"
Joiners (requires slots)	TC1279-98	TC1279-73	TC1279-226	TC1279-27	TC1279-25	TC1279-320KIT	N/A
Slotless joiners	N/A	N/A	TC1279-459A	TC1279-248A	TC1279-250A	TC1279-287A	TC1279-410A

## Vertical elbows

WBT YellowDuct vertical elbows are used to connect horizontal routes at different height, or to allow the fibre path to be raised or lowered to avoid obstacles. Retrofit versions are used where there is existing fibre. They are available with or without covers.



SIZE (MM) SIZE (INCHES)	30 X 30 1.25" X 1.25"	50 X 50 2" X 2"	100 X 50 4" X 2"	100 X 100 4" X 4"	220 X 100 8" X 4"	300 X 100 12" X 4"	600 X 100 24" X 4"
30° down	TC1279-135-30	TC1279-87-30	N/A	TC1279-111-30	TC1279-123-30	N/A	N/A
30° down & cover	TC1279-135-30A	TC1279-87-30A	N/A	TC1279-111-30A	TC1279-123-30A	N/A	N/A
30° down retrofit	N/A	N/A	N/A	TC1279-111-30R	TC1279-123-30R	N/A	N/A
30° up	N/A	N/A	N/A	TC1279-113-30	TC1279-125-30	N/A	N/A
30° up & cover	N/A	N/A	N/A	TC1279-113-30A	TC1279-125-30A	N/A	N/A
30° up retrofit	N/A	N/A	N/A	TC1279-113-30R	TC1279-125-30R	N/A	N/A
45° down	TC1279-135-45	TC1279-87-45	N/A	TC1279-111-45	TC1279-123-45	TC1279-285	N/A
45° down & cover	TC1279-135-45A	TC1279-87-45A	N/A	TC1279-111-45A	TC1279-123-45A	TC1279-285A	N/A
45° down retrofit	N/A	N/A	N/A	TC1279-111-45R	TC1279-123-45R	N/A	N/A
45° up	N/A	TC1279-143-45	N/A	TC1279-113-45	TC1279-125-45	TC1279-283	N/A
45° up & cover	N/A	TC1279-143-45A	N/A	TC1279-113-45A	TC1279-125-45A	TC1279-283A	N/A
45° up retrofit	N/A	TC1279-143-45R	N/A	TC1279-113-45R	TC1279-125-45R	N/A	N/A
90° down	TC1279-135	TC1279-87	TC1279-236	TC1279-111	TC1279-123	TC1279-193	TC1279-425A
90° down & cover	TC1279-135A	TC1279-87A	TC1279-236A	TC1279-111A	TC1279-123A	TC1279-193A	N/A
90° down retrofit	N/A	TC1279-87R	TC1279-236R	TC1279-111R	TC1279-123R	N/A	N/A
90° up	TC1279-247	TC1279-143	TC1279-246	TC1279-113	TC1279-125	TC1279-298A	N/A
90° up & cover	TC1279-247A	TC1279-143A	TC1279-246A	TC1279-113A	TC1279-125A	TC1279-298KIT	N/A
90° up retrofit	TC1279-247R	TC1279-143R	TC1279-246R	TC1279-113R	TC1279-125R	N/A	N/A
90° up & down enclosed	N/A	N/A	N/A	TC1279-39A	TC1279-37A	N/A	N/A



## Horizontal elbows

WBT YellowDuct horizontal elbows are used to change the direction of horizontal routes. They are available with or without covers.



TC1279-269



TC1279-29A

SIZE (MM) SIZE (INCHES)	30 X 30 1.25" X 1.25"	50 X 50 2" X 2"	100 X 50 4" X 2"	100 X 100 4" X 4"	220 X 100 8" X 4"	300 X 100 12" X 4"	600 X 100 24" X 4"
30° elbow	TC1279-137-30	TC1279-77-30	N/A	TC1279-47	TC1279-45	N/A	N/A
30° elbow & cover	TC1279-137-30A	TC1279-77-30A	N/A	TC1279-47A	TC1279-45A	N/A	N/A
45° elbow	TC1279-137-45	TC1279-77-45	N/A	TC1279-31-45	TC1279-29-45	TC1279-304	TC1279-414
45° elbow & cover	TC1279-137-45A	TC1279-77-45A	N/A	TC1279-31-45A	TC1279-29-45A	TC1279-304A	N/A
90° elbow	TC1279-137	TC1279-77	TC1279-269	TC1279-31	TC1279-29	TC1279-387	TC1279-411A
90° elbow & cover	TC1279-137A	TC1279-77A	TC1279-269A	TC1279-31A	TC1279-29A	TC1279-387A	N/A

## Horizontal tees

WBT YellowDuct horizontal tees may be used to branch off the main route or provide a method of breaking into horizontal duct. They are available with or without covers.

Note: Horizontal tees can also be used as a means of drop off.



TC1279-316A

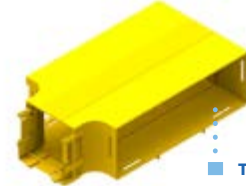

TC1279-398A

SIZE (MM) SIZE (INCHES)	30 X 30 1.25" X 1.25"	50 X 50 2" X 2"	100 X 50 4" X 2"	100 X 100 4" X 4"	220 X 100 8" X 4"	300 X 100 12" X 4"	600 X 100 24" X 4"
Horizontal tee	TC1279-115	TC1279-75	TC1279-224	TC1279-03	TC1279-01	TC1279-279	TC1279-412
Horizontal tee & cover	TC1279-115A	TC1279-75A	TC1279-224A	TC1279-03A	TC1279-01A	TC1279-279A	N/A
300mm - 220mm duct horizontal tee & cover		TC1279-316A	220mm - 100mm duct horizontal tee & cover			TC1279-09A	N/A
300mm - 100mm duct horizontal tee & cover		TC1279-398A	100mm - 220mm duct horizontal tee & cover			TC1279-393A	N/A

## Vertical tees (downspouts) - intrasuite assemblies

WBT YellowDuct vertical tees can be used to drop cables vertically from horizontal routes into frames or cabinets. Retrofit tees provide open access and are used where cables are already in place. They are available with or without covers.

Can also be used as drop-offs.



TC1279-11A



TC1279-277

SIZE (MM) SIZE (INCHES)	30 X 30 1.25" X 1.25"	50 X 50 2" X 2"	100 X 50 4" X 2"	100 X 100 4" X 4"	220 X 100 8" X 4"	300 X 100 12" X 4"	600 X 100 24" X 4"
30 x 30mm drop	TC1279-167	N/A	N/A	N/A	N/A	N/A	N/A
30 x 30mm drop & cover	TC1279-167A	N/A	N/A	N/A	N/A	N/A	N/A
50 x 50mm drop	N/A	TC1279-145	N/A	N/A	N/A	N/A	N/A
50 x 50mm drop & cover	N/A	TC1279-145A	N/A	N/A	N/A	N/A	N/A
50 x 50mm drop retro	N/A	TC1279-145R	N/A	N/A	N/A	N/A	N/A
100 x 50mm drop	N/A	N/A	TC1279-228	N/A	N/A	N/A	N/A
100 x 50mm drop & cover	N/A	N/A	TC1279-228A	N/A	N/A	N/A	N/A
100 x 100mm drop	N/A	N/A	N/A	TC1279-63	TC1279-11	N/A	N/A
100 x 100mm drop & cover	N/A	N/A	N/A	TC1279-63A	TC1279-11A	N/A	N/A
100 x 100mm drop retro	N/A	N/A	N/A	TC1279-63R	TC1279-11R	N/A	N/A
220 x 100mm drop	N/A	N/A	N/A	N/A	N/A	TC1279-277	N/A
220 x 100mm drop & cover	N/A	N/A	N/A	N/A	TC1279-329A	TC1279-277A	N/A

## Horizontal crosses

WBT YellowDuct horizontal crosses can be used to provide a cross intersection in straight duct.

Reduction crosses join horizontal duct of different sizes.



SIZE (MM) SIZE (INCHES)	30 X 30 1.25" X 1.25"	50 X 50 2" X 2"	100 X 50 4" X 2"	100 X 100 4" X 4"	220 X 100 8" X 4"	300 X 100 12" X 4"	600 X 100 24" X 4"
Horizontal cross	N/A	TC1279-139	TC1279-234	TC1279-71	TC1279-61	TC1279-300	TC1279-416
Horizontal cross & cover	N/A	TC1279-139A	TC1279-234A	TC1279-71A	TC1279-61A	TC1279-300A	N/A
Reduction cross	220 x 100 to 100 x 100		TC1279-65	220 x 100 to 300 x 100		TC1279-331	N/A
Reduction cross & cover	220 x 100 to 100 x 100		TC1279-65A	220 x 100 to 300 x 100		TC1279-331A	N/A
Reduction cross	300 X 100 to 100 x 100		TC1279-396				
Reduction cross & cover	300 X 100 to 100 x 100		TC1279-396A				

## Fibre storage loops

WBT YellowDuct fibre storage loops are used to safely store excess optical fibre cable lengths and can be placed in any horizontal route or inside cabinets. They are available in inline or offset versions.



SIZE (MM) SIZE (INCHES)	30 X 30 1.25" X 1.25"	50 X 50 2" X 2"	100 X 50 4" X 2"	100 X 100 4" X 4"	220 X 100 8" X 4"	300 X 100 12" X 4"	600 X 100 24" X 4"
Inline	N/A	TC1279-209KIT	TC1279-186KIT	TC1279-208KIT	TC1279-207KIT	TC1279-485KIT	N/A
Offset	N/A	TC1279-178KIT	TC1279-195KIT	TC1279-192KIT	TC1279-191KIT	TC1279-315KIT	N/A

## Adaptors

WBT YellowDuct adaptors are used to connect parts from other products to the YellowDuct ducting raceway, ADC and Panduit ducts. Most other ducting brands can be slotted with a WBT slotting tool to suit one of our slotted joiners.



DESCRIPTION	PART NO.
Adaptor kit 100 x 100 YellowDuct to ADC 4"	TC1279-109KIT
Adaptor kit left hand YellowDuct 220 x 100mm to ADC 6"	TC1279-149KIT
Adaptor kit right hand YellowDuct 220 x 100mm to ADC 6"	TC1279-150KIT
Adaptor kit 100mm vertical YellowDuct to ADC 4",6" or 12"	TC1279-307SLKIT
Adaptor kit YellowDuct 300 x 100mm to ADC 12"	TC1279-327KIT
Adaptor kit right hand YellowDuct 100 x 100mm to ADC 6"	TC1279-472KIT
Adaptor kit left hand YellowDuct 100 x 100mm to ADC 6"	TC1279-473KIT
Adaptor kit right hand YellowDuct 220 x 100mm to Panduit 6"	TC1279-486KIT
Adaptor kit left hand YellowDuct 220 x 100mm to Panduit 6"	TC1279-487KIT
Adaptor kit YellowDuct 300 x 100mm to 12" x 4" Panduit duct	TC1279-492KIT
Adaptor kit 100mm YellowDuct to 4" Panduit duct	TC1279-173KIT

## End caps

WBT YellowDuct end caps are used to close off the end of a horizontal or vertical route of duct. Some are sealed, others have knock outs or spigots for convoluted tubing or fibre feedout.



TC1279-127B



TC1279-57D



TC1279-456

SIZE (MM) SIZE (INCHES)	30 X 30 1.25" X 1.25"	50 X 50 2" X 2"	100 X 50 4" X 2"	100 X 100 4" X 4"	220 X 100 8" X 4"	300 X 100 12" X 4"	600 X 100 24" X 4"
Sealed	N/A	N/A	TC1279-227	TC1279-57	TC1279-56	N/A	N/A
Sealed (for use with slotless joiners)	N/A	N/A	N/A	TC1279-251	TC1279-252	TC1279-288	TC1279-435
1x 17mm knockout	TC1279-128	N/A	N/A	N/A	N/A	N/A	N/A
Tube outlet for 32mm tube	TC1279-128D	N/A	N/A	N/A	N/A	N/A	N/A
2 x 20mm dia knockouts	N/A	TC1279-127	N/A	N/A	N/A	N/A	N/A
1 x 38mm dia knockout	N/A	TC1279-127B	N/A	N/A	N/A	N/A	N/A
1 x 38mm cutout	N/A	TC1279-127C	N/A	N/A	N/A	N/A	N/A
Tube outlet for 50mm tube	N/A	TC1279-127D	N/A	N/A	N/A	N/A	N/A
2 x 32mm dia knockouts	N/A	N/A	N/A	TC1279-57B	N/A	N/A	N/A
2 x 46mm dia holes	N/A	N/A	N/A	TC1279-57C	N/A	N/A	N/A
End support bracket	N/A	TC1279-127F	N/A	TC1279-57D	N/A	N/A	N/A
88mm tube outlet	N/A	N/A	N/A	TC1279-456	N/A	N/A	N/A
Dual 88mm tube outlets	N/A	N/A	N/A	N/A	TC1279-457	N/A	N/A

## Tubing

WBT YellowDuct tubing is used for feeding entering or exiting optical fibres from the ducting raceway into equipment racks. They are convoluted or ribbed, to allow adjustment if drops cannot be positioned exactly over or under equipment. Some are available with removable covers, or split for ease of cable installation.

Square convoluted tube



Openable convoluted tube



Round convoluted tube



DESCRIPTION	YELLOW	BLACK
Convoluted tube 50mm dia (1 meter length)	TC1279-26Y	TC1279-26
Convoluted tube 50mm dia (2 meter length)	TC1279-53Y	TC1279-53
Convoluted tube 25mm dia (2 meter length)	N/A	TC1279-54 *
Convoluted tube 38mm dia (2 meter length)	N/A	TC1279-68
Convoluted tube 50mm square (350mm length)	TC1279-85YEL	TC1279-85BLK
Openable convoluted tube with cover 50mm square (350mm length)	TC1279-85KIT	N/A
Convoluted tube 30mm square (350mm length)	TC1279-88	N/A
Convoluted tube split 20mm dia (2 meter length)	N/A	TC1279-100 *
Convoluted tube split with cover 50mm dia (1 meter length)	N/A	TC1279-350
Convoluted tube, flexible, 75mm ID/88mm OD x 2 metres long	TC1279-458	N/A
Convoluted tube, flexible, 75mm ID/88mm OD x 1 metres long	TC1279-458-1	N/A
Convoluted tube, flexible, 65mm ID/83mm OD x 2 metres long	TC1279-471	N/A
Convoluted tube, flexible, 65mm ID/83mm OD x 1 metres long	TC1279-471-1	N/A
Convoluted tube, flexible, 75mm ID/88mm OD x 1.15 metres long	TC1279-479	N/A
Convoluted tube 63mm ID/ 65mm OD x 1.1 metres, c/w two joiners to connect to 75mm ID/88mm OD convoluted tube	TC1279-480A	N/A
Convoluted tubing adaptor kit, 75mm ID/ 88mm OD to 44mm ID/ 50mm OD tubing	TC1279-494KIT	N/A

\*Grey

## Reducers

WBT YellowDuct reducers allow different size ducts to be joined together. They are available with or without covers.

TC1279-07A



MAIN SIZE (MM) REDUCTION SIZE (MM)	50 X 50 30 X 30	100 X 50 50 X 50	100 X 100 50 X 50	100 X 100 100 X 50	220 X 100 100 X 100	300 X 100 220 X 100	600 X 100 300 X 100
Reducer	TC1279-97	TC1279-238	TC1279-91	TC1279-240	N/A	TC1279-281	TC1279-408
Reducer & cover	TC1279-97A	TC1279-238A	TC1279-91A	TC1279-240A	N/A	TC1279-281A	N/A
Reducer right hand	N/A	N/A	N/A	N/A	TC1279-05	N/A	N/A
Reducer right hand & cover	N/A	N/A	N/A	N/A	TC1279-05A	N/A	N/A
Reducer left hand	N/A	N/A	N/A	N/A	TC1279-07	N/A	N/A
Reducer left hand & cover	N/A	N/A	N/A	N/A	TC1279-07A	N/A	N/A

## Low profile ducting solution

220mm x 50mm (8" x 2")

The low profile duct solution can be used as a bridging adaptor and interconnection between two parallel lengths of duct where ceiling height constraints are an issue.

TC1279-461KIT includes the following:

- 2 x TC1279-461A over the top outlets
- 2 x TC1279-482 Joiners
- 1 x 0.66m length of low profile 220mm duct with cover

<b>Solid duct only</b>	TC1279-392
<b>Solid duct with snap on cover</b>	TC1279-392ASN

Provides a horizontal exit for optical fibre cords, anywhere along a straight 100mm, 220mm or 300mm duct run. The unit simply fits along the edge of the duct – i.e., the side of the duct is not specially prepared or cut. The outlet curve has no ribs so there is nothing to restrict the naturally occurring free flow of optical fibre cords. By altering the length of the connecting 220mm x 50mm duct, different offset spacings for duct systems can be made. Easily installed without having to cut or prepare the side of the duct.

Low profile straight duct lengths require the use of Slotted Joiners which are simple to install.

220mm x 50mm (8" x 2") - 2m lengths

The joiner is used to connect low height, 220mm x 50mm straight ducting to a top outlet assembly, horizontal outlet.

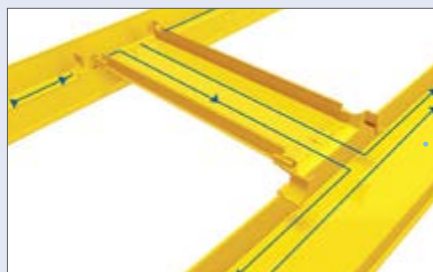

Interconnection between 2 parallel duct lengths where there are ceiling height constraints

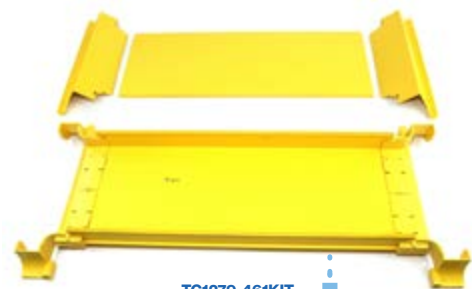

TC1279-461KIT  
Low profile duct  
system joining kit



Straight  
duct lengths



TC1279-482  
Joiner



TC1279-461A  
Outlet

# Data rack ducting & accessories

The Warren & Brown optical fibre ducting raceway is an Australian made solution for managing, routing and protecting fibre optic cords between termination equipment, patch panels and fibre optic splicing cabinets or frames. This cost effective and reliable solution has been used in telecommunications exchanges, data centres, universities, hospitals, or anywhere fibre optic cabling is present.

## External cable entry elbow

This 90° elbow is typically used to feed an optical fibre cable into a cabinet after the cable has "broken-out" into several optical fibres where ducting is not present. The elbow is fastened to the cabinet using an M50 nut, after passing through a clearance hole. The lower end of the elbow can accept either a 38mm dia. cable; or a convoluted tube, which houses the incoming optical fibre cable. The inner radius of the elbow is 56mm, and the internal diameter is 41.5mm; so, the elbow can typically accept a cable of around 37/38mm dia.

## Top outlet vertical drop & plastic mounting clips

The top outlet vertical drop can be attached to YellowDuct, metal tray and wire basket tray.

A pair of plastic mounting clips enables an over the top outlet (TC1279-290A & TC1279-307A) to be fitted to the existing wire basket or metal ductwork.

This enables optical fibre cords to leave the duct run at any position along its length, whilst maintaining the MBR at 30mm. The over the top outlet allows optical fibre cords to "drop-off" the duct run and feed equipment racks.



**The ducting raceway range keeps growing and evolving as new products and solutions are developed and introduced.**



TC1279-434  
Elbow, 90°, M50 X 1.5



TC1279-531ASL  
50mm top outlet vertical drop

This top outlet vertical drop also fits existing metal ductwork.



TC1279-307ASLS  
100mm top outlet vertical drop



TC1279-307S-2  
Mounting clips

# Drop-off solutions

**These components provide different methods of allowing fibres to enter or leave the fibre optic ducting raceway. They can be purchased as kits or as individual items.**

## Side spill out kit

This drop-off assembly can be installed anywhere along the length of a 100mm high duct to allow up to 80 x 2mm optical fibre cords to leave the duct horizontally or vertically (if installed on the floor of the straight duct). Use cut out tool / hole saw TC1279-604KIT with a drill to make a cut into the ducting.



**TC1279-602A**  
Duct side spill out, straight outlet to convoluted tubing



**TC1279-609A**  
Duct side spill out, 90°, up / down / left / right to convoluted tubing



## Side drop-off kits - 50 x 50mm exit

50mm (2") duct drop-off solutions are suitable for 50 x 50mm, 100 x 50mm, 100 x 100mm, 220 x 100mm and 300 x 100mm straight duct lengths.

- Use tool TC1279-50KIT to make cut-out in side of duct (or template 483A)
- Round convoluted tube, square convoluted tube and straight duct components ordered separately



**TC1279-41KIT**  
50mm (2") side drop-off (outlet) to 50mm dia. round convoluted tube

- Can fit approx. 80 x 2mm cables
- Also includes duct ramp



**TC1279-41A**  
50mm (2") side drop-off (outlet only)

- Can fit approx. 80 x 2mm cables



**TC1279-89KIT**  
Side drop-off to 50mm (2") square convoluted tube

- Can fit approx. 100-150 x 2mm cables
- Also includes duct ramp





**TC1279-89A**  
Side drop-off (outlet) to 50mm square only  
• Can fit approx. 100-150 x 2mm cables.

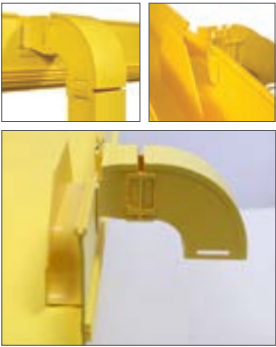

**TC1279-93KIT**  
Side drop-off kit to 50mm ducting raceway  
• Can fit between 100-150 x 2mm cables  
• Full kit for vertical drop (includes duct outlet, duct ramp, joiner and vertical elbow)  
• Straight duct lengths ordered separately

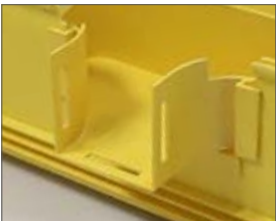

**TC1279-93A**  
Side drop-off outlet to 50mm ducting raceway  
• Can fit between 100-150 x 2mm cables  
• Straight duct lengths, duct ramp, joiner and elbow ordered separately



## Side drop off kits - 100 x 50mm exit

100 x 50mm duct drop-off solutions are suitable for 50 x 50mm, 100 x 50mm, 100 x 100mm, 220 x 100mm and 300 x 100mm straight duct lengths.

- Use tool TC1279-231KIT to make cut-out in side of duct.
- Straight duct components ordered separately

\* Down elbow not included in kit. Ordered separately - TC1279-236A

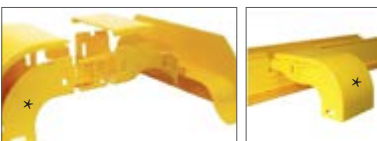

**TC1279-232KIT**  
Side drop-off to 100mm x 50mm ducting raceway  
• Can fit approx. 250-300 x 2mm cables  
• Also includes duct ramp (TC1279-294)



**TC1279-232A**  
Side drop-off (outlet only) to 100mm x 50mm ducting raceway  
• Can fit between 250-300 x 2mm cables



## Side drop-off kits - 100 x 100mm exit

100 x 100mm duct drop-off solutions are suitable for 100 x 50mm, 100 x 100mm, 220 x 100mm and 300 x 100mm straight duct lengths.

- Use tool TC1279-231 to make cut-out in side of duct.
- Straight duct components ordered separately

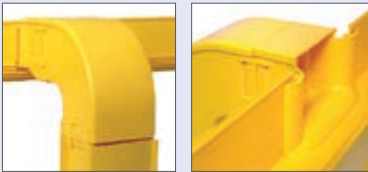

### TC1279-111KIT

Side drop-off to 100mm x 100mm ducting raceway

- This drop can fit between 500-600 x 2mm cables.
- Use tool TC1279-231 to make cut-out in side of duct.



### TC1279-218A

Side drop-off (outlet only) to 100mm x 100mm ducting raceway

- This outlet can fit between 500-600 x 2mm cables.
- Use tool TC1279-231KIT or template 483A to make cut-out in side of duct.



## Express top outlet (clip on) drop-off kits 100 x 100mm exit

100 x 100mm express top outlet drop-off solutions are suitable for 100 x 50mm, 100 x 100mm, 220 x 100mm and 300 x 100mm straight duct lengths. These style outlets simply clip onto the top of the ducting raceway, providing an express outlet (drop) along a length of ducting. No slotting, bolting or cutting is required for installing these components onto the straight duct length.

- Simply clips onto the top of a straight duct length
- Straight duct components ordered separately

### TC1279-290ASL - WITH SLOTS

#### TC1279-290A

Express top outlet drop-off to 100mm x 100mm ducting raceway, horizontal

- This drop can fit between 300-400 x 2mm cables.



### TC1279-307ASL - WITH SLOTS

#### TC1279-307A

Express top outlet drop-off to 100mm x 100mm ducting raceway, vertical

- This drop can fit between 300-400 x 2mm cables.





## High capacity duct outlets

These duct outlet kits provide the ideal solution for high capacity optical fibre cords. Duct outlets can be placed anywhere along the duct and minimal time and effort is required to install these outlet components. This solution allows for quick installation, as less cuts are required and is also stronger, as the ribs of duct are not cut.

- Simply clips onto the top of a straight duct length
- Straight duct components ordered separately



### TC1279-452A

High capacity outlet, 100mm x 100mm (4" x 4") 90°

- Provides a 90° down bend (and break-out facility) at any point in a 100mm, 220mm or 300mm duct system.
- Can accept any standard 100mm x 100mm duct item using a joiner.

### Kit includes:

- TC1279-452 (90° down body)
- TC1279-453 (90° down Lid)

### TC1279-452KIT

High capacity outlet kit, single, 100mm x 100mm (4" x 4") 90°

- Provides a 90° down bend tube in a 100mm, 220mm or 300mm duct system.
- The 75mm ID/88 mm OD tube can carry either: 360 x 2mm cords; 210 x 2.4mm cords; or 160 x 3mm dia cords maximum.
- Use template 483A for cutout

### Kit includes:

- 1x TC1279-452A
- 1x 2m long convoluted tube TC1279-458
- 1x TC1279-456 convoluted tube outlet



### TC1279-454KIT

High capacity outlet kit, dual, 220mm x 100mm (8" x 4") 90°

- Provides a 90° down bend for two large size convoluted tubes in a 100m, 220mm or 300mm duct system.
- Each 75mm ID tube can carry up to 360 x 2mm cords.
- Use template 483A for cutout

### Kit includes:

- 1x TC1279-454A
- 2 x 2m long convoluted tubes TC1279-471
- 1x TC1279-457 dual convoluted tube outlet

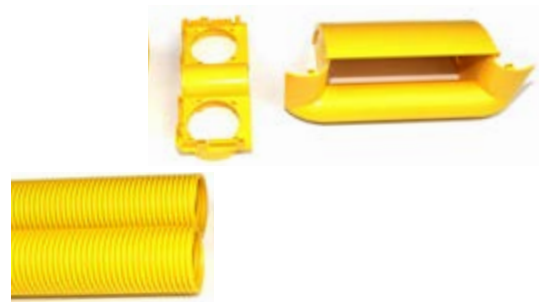

### TC1279-454A

High capacity outlet, 220mm x 100mm (8" x 4") 90°

- Provides a 90° down bend (and break-out facility) at any point in a 100mm, 220mm or 300m duct system.
- Can accept any standard 220mm x 100mm duct item using a joiner.
- Use template 483A for cutout

### Includes:

- TC1279-454 (90° down body)
- TC1279-455 (90° down Lid)



## Other duct drop-off components



**TC1279-212KIT**  
Radius guide (pack of 10) to suit 30mm, 50mm, 100mm slotted duct



**RAMP UP**  
TC1279-42 small ramp up  
TC1279-294 large ramp up



**OUTLET TRUMPET**  
TC1279-93A 50 x 50mm  
TC1279-218A 100 x 100mm  
TC1279-330A 100 x 220mm  
TC1279-379A 100 x 300mm

## Miscellaneous items



**TC1279-156**  
**Universal radius guide**  
This guide is a simple means of providing a 30mm radius guide that eliminates fibre stress through bending.



**TC1279-72KIT**  
**Pigtail radius guide kit**  
The pigtail radius guide provides a 90° bend, but the guides are interlocking so that many can be joined to form U turns, circles & spirals as required (10 per kit).



**TC1279-570KIT**  
**Duct cable separator kit for 100mm, 220mm and 300mm duct**  
The duct cable separator kit is installed longitudinally along the length of a duct run, to provide a separator or divider in the duct. The item is used to create separate compartments for different cords or cables.

## PVC slotted duct

This slotted duct is used for dropping off optical fibres from the overhead ducting system to racks & equipment subracks.

PART NO.	DESCRIPTION
TC1279-55KIT	50 x 50mm x 2m
TC1279-58KIT	25 x 30mm x 2m
TC1279-99KIT	60 x 40mm x 2m (not slotted)

**TC1279-99KIT**



**TC1279-55KIT**



# Mounting solutions

**WBT YellowDuct mounting hardware is used to support the ducting raceway from different structures.**

Although the most common components are shown here, many other components that have been developed for specific applications or customer requests are also available. Mounting systems are also available for retro-fitting to existing installations. Custom components can also be manufactured to your specifications. Please contact your WBT sales office or distributor for assistance.

## Metal mounting kits steel work or wall mounting

Provides vertical & horizontal mounting flexibility to steel-work or walls.



**TC1279-438A**

600mm x 100mm duct mounting bracket assembly



**TC1279-103KIT**

100mm duct support mounting bracket kit



**TC1279-104KIT**

100mm duct wall mounting bracket

The wall mounting bracket is used to attach 100mm plastic duct to any existing structure.



**TC1279-133KIT**

220mm duct wall mounting bracket kit

The wall mounting bracket is used to attach 220mm plastic duct to any existing structure.

*Note: Version for 100mm duct is TC1279-104KIT.*



**TC1279-161KIT**

30, 50, 100mm wall mounting extension kit

This flexible mounting kit is used to provide a means of attaching 30mm, 50mm and 100mm duct to any existing structure.

*Note: Individual duct "C" type brackets are required in addition to this kit (see mounting hardware).*



**TC1279-183KIT**

Mounting bracket kit, heavy duty, wall & strut

This kit has two vertical slots suited to wall or Unistrut™ mounting and provides a single long slot to accept duct mounting brackets up to 220mm size.

*Note: Individual duct "C" type brackets are required in addition to this kit (see mounting hardware).*



**TC1279-168KIT**

Horizontal mounting kit, 50mm

This mounting kit is a simple adjustable means of mounting 50mm duct in a vertical or horizontal plane. It can be used to mount duct in equipment racks and as vertical risers, etc. It includes heavy duty, adhesive backed hook & loop tape, to ensure flexible mounting without movement.



**TC1279-130KIT**

Mounting bracket kit for 30mm, 50mm duct

This kit is a simple and adjustable means of attaching or mounting either 50mm or 30mm duct, in either a vertical or horizontal plane.



**TC1279-78KIT**

Mounting bracket kit for 30mm, 50mm duct

This is simply a bracket, that can be fixed to the duct and any existing building.



**TC1279-303A**

Side mounting bracket, heavy duty

This side mounting bracket is used to install & secure 100mm, 220mm, 300mm duct to existing threaded rods.

*Note: Used in conjunction with "C" type mounting hardware.*



**TC1279-102**

Wall mounting bracket



**TC1279-126KIT**

Wall mounting bracket kit, horizontal

**Mounting hardware duct "C" type brackets**

This assembly consists of a standard 30mm (50mm, 100mm, 220mm, 300 mm) duct support bracket. This assembly is used where the duct is directly mounted to flat brackets with 13mm (1/2" clearance) dia holes.

**TC1279-147A**



## Suspension kits

These suspension mounting bracket kits are used to attach either 300mm, 220mm or 100mm plastic duct to existing steelwork, from above.

Note: All metal brackets are either nickel plated or black powdercoat paint.



**TC1279-297KIT**

300mm heavy duty suspension duct mounting kit



**TC1279-106KITA**

220mm duct suspension bracket kit (including 12mm threaded rod)

**TC1279-106KITB**

220mm duct suspension bracket kit (including 16mm threaded rod)



**TC1279-297AKIT**

300mm x 100mm duct system, mounting bracket kit, suspension type, 1/2" with threaded rod

**TC1279-297BKIT**

300 x 100mm duct system, mounting bracket kit, suspension type, 5/8" with threaded rod



**TC1279-107KITA**

100mm duct suspension bracket kit (including 12mm threaded rod)

**TC1279-107KITB**

100mm duct suspension bracket kit (including 16mm threaded rod)



**TC1279-106KIT**

220mm duct suspension bracket kit



**TC1279-107KIT**

100mm duct suspension bracket kit

## Underfloor mounting kits

### TC1279-274

Under floor mounting bracket



### TC1279-197KIT

Vertical strut mounting kit

This clamp is a means of attaching either a 220mm or 100mm duct system to (up to) 30mm (1") diameter tube or 25mm (1") square tubes in an under floor system.

Note: Used in conjunction with "C" type mounting hardware.



## Ladder rack mounting



### TC1279-370KIT

100, 220, 300mm Ladder rack mount kit, large

This clamp is a means of attaching either 100mm, 220mm or 300mm duct systems to 1" and 2" ladder racks.

*Note: Heavy duty. Used in conjunction with "C" type mounting hardware.*



### TC1279-154KIT

Ladder rack mount assembly, 30mm and 50mm duct

These clamps are a means of fixing either 30mm and 50mm duct systems to 1.5" and 2" ladder racks.

*Note: Used in conjunction with "C" type mounting hardware.*



### TC1279-155KIT

Ladder rack mount kit, 100mm and 220mm duct

These clamps are a means of fixing either 100mm, 220mm duct systems to 1.5" and 2" ladder racks.

*Note: Used in conjunction with "C" type mounting hardware.*



### TC1279-572KIT

Support bracket, 220mm x 100mm duct

This supporting bracket set, enables a 220mm x 100mm duct system to be installed in the aisle, below the overhead super structure, in front of the racks to be serviced.

## Unistrut™ mounting

### TC1279-171

Mounting bracket adaptor

This bracket fits over 2" (50mm) square Unistrut™ section to provide a strong fixing position for: 300mm, 220mm and 100mm duct mounting brackets.

*Note: Used in conjunction with "C" type mounting hardware.*

### TC1279-170

Bracket to suit Siemens frame

### TC1279-59

Bracket to suit 41mm strut





## “C” Rail mounting kits

These kits are attached to the rail by two screws. Multiple holes provide vertical adjustment in 21mm increments.

- Simple clamp system adapts to “C” rail
- Suits 100mm, 220mm or 300mm duct systems
- Includes: nuts, screws and washers



**TC1279-155AKIT**  
 “C” rail mounting kit, 100mm duct  
*Note: Includes 100mm duct bracket.*



**TC1279-155BKIT**  
 “C” rail mounting kit, 220mm duct  
*Note: Includes 220mm duct bracket.*



**TC1279-155CKIT**  
 “C” rail mounting kit, 300mm duct  
*Note: Includes 300mm duct bracket.*

## Raised mounting kits



**TC1279-13A**  
 Mounting bracket assembly,  
 220mm duct with M12 threaded rod  
 The mounting bracket provides an adjustable mounting mechanism for the 220mm plastic ducting system.



**TC1279-14A**  
 Mounting bracket assembly,  
 100mm duct with M12 threaded rod  
 The mounting bracket provides an adjustable mounting mechanism for the 100mm plastic ducting system.



**TC1279-129KIT**  
 Mounting plate kit, 30mm, 50mm duct  
 Is used for quick and easy attaching to 30mm & 50mm duct.

# Tooling components

## Ducting slotting tool - foot operated

Features & benefits:

- Ducting can be easily aligned and positioned on slotting jig
- Fast and easy to use slotting mechanism which slots in seconds
- Compact, easy to transport unit which only weighs 8kg
- Steady and robust platform
- Ergonomically designed, no stress or heavy manual operation required as it only requires leg power
- Conforms to OH&S standards
- Repeatedly produces accurate slots
- Slots an end of duct in less than 30 seconds

Note: Ideal for large installations.

DUCT SIZE (MM)	DUCT SIZE (INCHES)	PART NO.
100mm x 100mm	4" x 4"	TC1279-23
220mm x 100mm	8" x 4"	TC1279-21
300mm x 100mm	12" x 4"	TC1279-275



TC1279-500KIT

PART NO.	DESCRIPTION
TC1279-500KIT	Foot operated duct slotting tool (with tool box)
TC1279-500-13	Tool box - suit foot slotter (tool box only)

## Side slotting tool

The slotting tool is used to make a small slot in the bottom and both sides at the end/s of duct. This process is a simple mechanical means of preparing a shortened length duct for connection to another standard part: e.g. elbow, cross connector, tees, adaptor assembly, duct end or drop offs, etc.



PART NO.	DESCRIPTION
TC1279-230	for 100mm x 50mm duct (side slots only)
TC1279-51	for 100mm x 50mm duct (base slots only), for 220mm x 100mm, 300mm x 100mm, 100mm x 100mm
TC1279-118	for 50mm duct
TC1279-121A	for 30mm duct





## Ducting hydraulic hand held slotting tool

The hand held hydraulic duct slotting tool is a revolutionary design that takes the stress and effort out of slotting duct. Take advantage of this new method of safely and easily slotting ducting, which will improve the efficiency of your installations and save you and your customer time and money.

DUCT SIZE (MM)	DUCT SIZE (INCHES)	PART NO.
100mm x 100mm	4" x 4"	TC1279-23
220mm x 100mm	8" x 4"	TC1279-21
300mm x 100mm	12" x 4"	TC1279-275

### Features & benefits:

- No need to exert excessive force since the unit is hydraulic powered
- Safe & easy to use
- Ergonomically designed
- Compact design which is easy to transport and doesn't require excess storage space.
- Saves you time by slotting duct quickly
- Allows you to slot an end of duct in less than 1 minute
- Lightweight, only 2kg
- Repeatedly produces accurate slots
- Slots a variety of duct sizes from 100mm x 50mm up to 300mm x 100mm



PART NO.	DESCRIPTION
TC1279-501	100mm hand hydraulic tool
TC1279-501-13S	100mm hand hydraulic tool head
TC1279-501KIT	100mm hand hydraulic tool kit with tool box

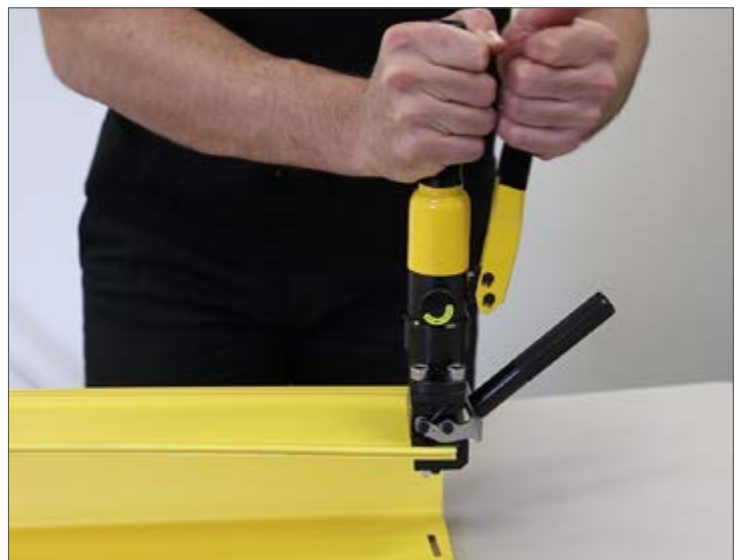

Look us up on Youtube for tooling instructional videos



## Mitre kits

Mitre boxes are used to provide a means of producing an accurate and straight cut on ducting, essential for correct alignment of the slotting tools and joiners.

TC1279-118-07  
Mitre box duct,  
50mm, 30mm

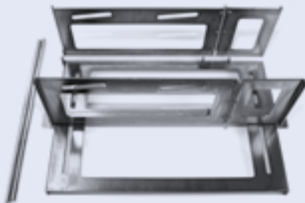
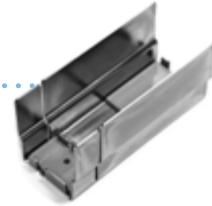

TC1279-MITRE  
Mitre box duct 300mm,  
220mm, 100mm



TC1279-483A  
Cut out jig, for drop-offs  
and break out guides  
- suitable for all ducts  
from 50mm to 300mm



## Duct spill out tool

This kit is used to cut the 60mm hole in the side and bottom of the duct to accommodate drop-outs (TC1279-602A, TC1279-609A)

*Note: If optic fibre cords already in duct, use TC1279-50-3 to protect the cords.*

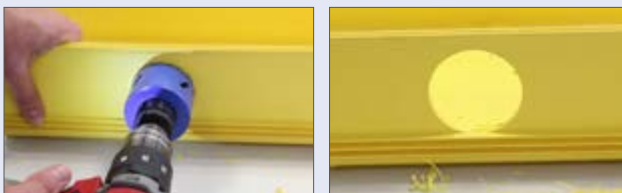

TC1279-604KIT  
Duct spill out and  
installation template



## Miscellaneous items



100X060  
Panel saw (jack)



TC1279-50-3  
Fibre spreader  
and protector



97X01  
Wrench, ratchet  
1/2" drive

62X001  
Socket

## Cut out tools

Cut out tools are used to cut notches in the side of the duct to accommodate drop-outs. They are supplied with a fibre spreader to protect previously installed fibres when using the tools.

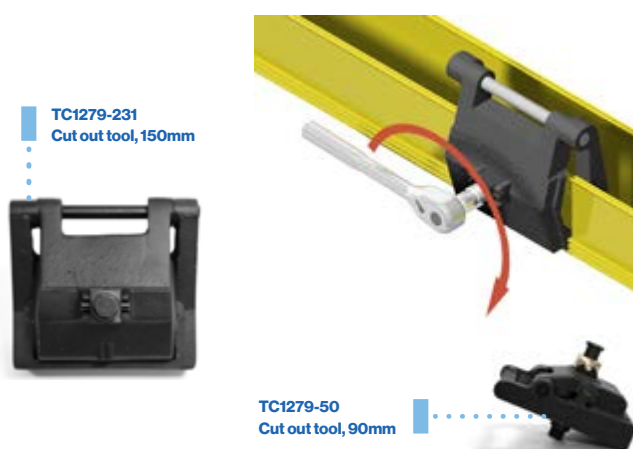

## Duct tool kits

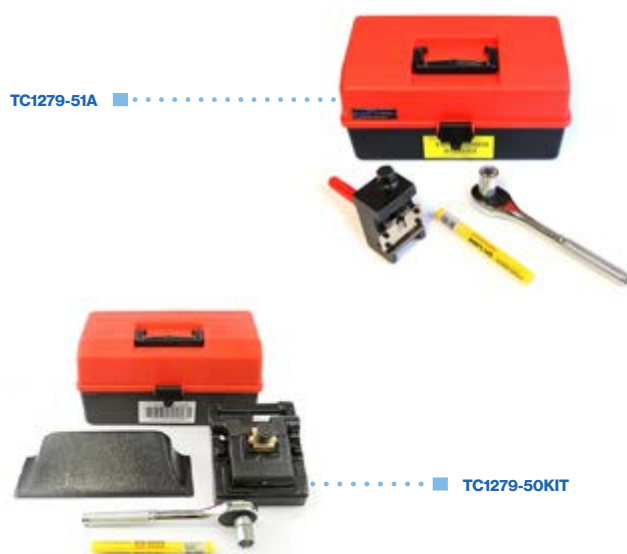

DESCRIPTION	PART NO.	+ MORE DETAILS	TC1279-140KIT 30,50MM SLOTING KIT	TC1279-118KIT 50MM SLOT & MITRE KIT	TC1279-51A 100, 220MM SLOT TOOL & WRENCH KIT	TC1279-51KIT 100, 220, 300MM CUT & SLOT KIT	TC1279-50KIT 100, 220MM CUT & SLOT KIT	TC1279-TKIT COMBINATION KIT	TC1279-231KIT 100, 220, 300MM CUT OUT TOOL KIT
Mitre kits	TC1279-118-07	30/50mm duct	YES	YES				YES	
	TC1279-MITRE	100/220/300mm duct				YES		YES	
Tool box	60X013				YES				
	60X016		YES	YES					
	60X003					YES		YES	
	60X002								YES
Slotting tool	TC1279-121A	for 30mm	YES					YES	
	TC1279-118	for 50mm	YES	YES				YES	
	TC1279-51	for 100x50mm (base only), 100/220/300mm			YES	YES		YES	
	TC1279-230	for 100x50mm (sides)						YES	
Cut out tool	TC1279-50	90mm cut					YES	YES	
	TC1279-231	150mm cut							YES
Wrench ratchet	97X01	small			YES	YES	YES	YES	
	97X02	large, 375mm handle							YES
Socket	62X001				YES	YES	YES	YES	YES
Fibre spreader	TC1279-50-3						YES	YES	YES
Grease stick	70X003		YES	YES	YES	YES	YES	YES	YES
Panel saw	100X060					YES		YES	

## WARREN & BROWN TECHNOLOGIES PTY LTD

**108 Mitchell Street,  
Maidstone, Victoria 3012**

Phone: (613) 9317 6888  
Fax: (613) 9318 6091  
Email: sales@wbt.com.au

### Europe

#### WTB Europe BV

Energieweg 45,  
1271 EC Huizen,  
The Netherlands

**Phone:** +31 35 2085653

**Email:** htovar@wbt.biz  
dkoning@wbt.biz

### Philippines

#### Warren & Brown Fiber Systems Corporation

BDG Building 2, Block 1, Lot 1,  
Solid Street. LIP, Mamplasan,  
Binan 4024, Laguna,  
Philippines

**Phone:** +63 2 584 4617  
+63 2 584 4510

**Fax:** +63 49 508 0011

**Email:** deoperff@  
warrenandbrown.com.au

### Vietnam

#### Warren & Brown Technologies Pty Ltd

R.02-11, 2nd Floor, D2 Building,  
Mandarin Garden, Hoang  
Minh Giam Str., Cau Giay  
District, Hanoi 10000, Vietnam

**Phone:** +84 4 6664 3388

**Fax:** +84 4 6664 3888

**Email:** wbtvn@  
warrenandbrown.com.au

### New Zealand

#### AC-WB Technologies

7 Old Wairoa Road, Papakura,  
Auckland, New Zealand

**Phone:** +64 9 302 2668

**Fax:** +64 9 302 2678

**Email:** sales@  
actechnologies.co.nz

### New South Wales

#### JCS-WB Technologies Pty Ltd

Unit 2, 2 Holker Street,  
Newington, NSW 2127

**Phone:** +61 2 8878 6600

**Fax:** +61 2 9808 2622

**Email:** sales@jcs-wbt.com.au