

Compact Termination Box MK2 4 fibres (CTBMK2 4fo)

CTBMK2 equipped with 4 SC/APC shutter adaptors and 4 G657A1 SC/APC pigtails:	<u>Reference:</u> XCPSC01229
CTBMK2 equipped with 4 SC/APC shutter adaptors:	XCPSC01136
1 shutter adaptors	XCPSC01227

Description	Tools & required additional products						
<p>The CTBMK2 4fo can be used:</p> <ul style="list-style-type: none"> - Installed on a wall. - installed on a DIN rail in Home Hub <p>The TTBMK2 can be supplied</p> <ul style="list-style-type: none"> - with up to 4 pigtails and shutter adaptors - Already equipped with a preconnectorised drop cable. <p>SPACE ENVELOPE : 100 mm x 83 mm x 28 mm (Lx Hx P)</p>	<table border="1" style="width: 100%; border-collapse: collapse;"> <thead> <tr> <th style="width: 60%;">Additional Items</th> <th style="width: 40%;">Prysmian Part No.</th> </tr> </thead> <tbody> <tr> <td>Fusion splice protection (45x2,2mm)</td> <td>XKTSC00050 (bag of 12) XPESC00053 (bag of 50)</td> </tr> <tr> <td>Mechanical splice protection</td> <td>XKTSC00121 (sachet de 50)</td> </tr> </tbody> </table> <p>Tools: Long Nose Pliers, Flush Cutters, Small File, Screwdriver, 6mm drill bit.</p>	Additional Items	Prysmian Part No.	Fusion splice protection (45x2,2mm)	XKTSC00050 (bag of 12) XPESC00053 (bag of 50)	Mechanical splice protection	XKTSC00121 (sachet de 50)
Additional Items	Prysmian Part No.						
Fusion splice protection (45x2,2mm)	XKTSC00050 (bag of 12) XPESC00053 (bag of 50)						
Mechanical splice protection	XKTSC00121 (sachet de 50)						

Component parts

<p>CTBMK2 Reference: XCPSC01229</p>	<p>A base, a splice tray, a main cover, an identification label, a wall support, transparent cover for the identification label area, a screw to fix the min cover to the base</p> <p style="text-align: right;">Quantity 1</p>
	<p>Tie rap 100 x 2.6mm</p> <p style="text-align: right;">Quantity 2</p>
	<p>SC/APC shutter adaptors</p> <p style="text-align: right;">Quantity 4</p>
	<p>Wall plugs + fixing screws</p> <p style="text-align: right;">Quantity 2</p>
	<p>SC/APC Pigtail G657A1</p> <p style="text-align: right;">Quantity 4</p>
	<p>Installation procedure</p> <p style="text-align: right;">Quantity 1</p>

Prysmian
Group
INSTALLATION INSTRUCTION

Index

Wall support Installation on a wall	Page 3/32
Wall support Installation on a 35mm DIN rail	Page 6/32
Main cover opening	page 8/32
Drop cable installation on a wall	Page 9/32
Other possibility of installation of the drop cable	Page 15/32
Splicing Procedure	Pages 18/32
CTBMK2 installation	Pages 23/32
CTBMK2 Labeling	Page 29/32
CTBMK2 removal	Page 32/32



Clean before you connect.

It is important that all fibre connectors and adapters are cleaned prior to mating using approved local practice. Failure to clean may result in either poor signal performance and/or permanent damage to the connector end faces.

Wall support Installation on a wall

A wall with a flat surface will be privileged to install the wall support

Step 1

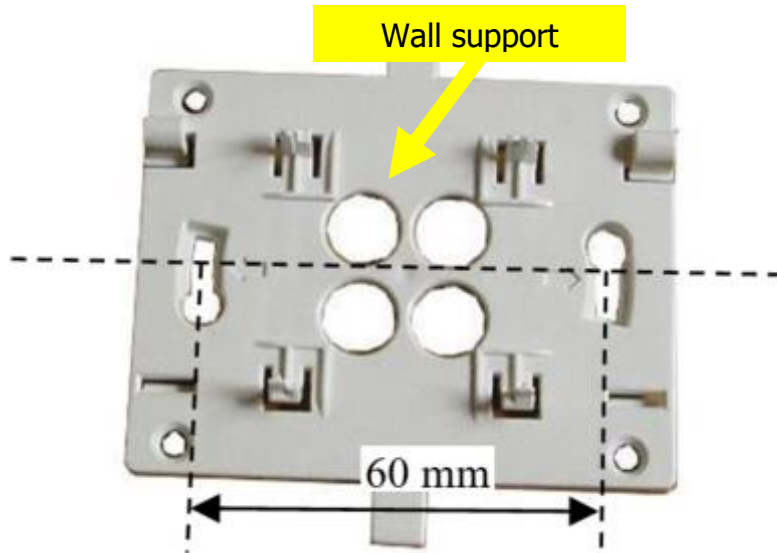

- Use a 6mm drill bit to make 2 holes 60 mm distant from each other.
- Insert the two wall plugs into the holes; insert the two screws in the wall plugs on few millimeters.
- Place the support over the screw and tie the screws to fix the support to the wall.

Wall support Installation on a wall

Step 2

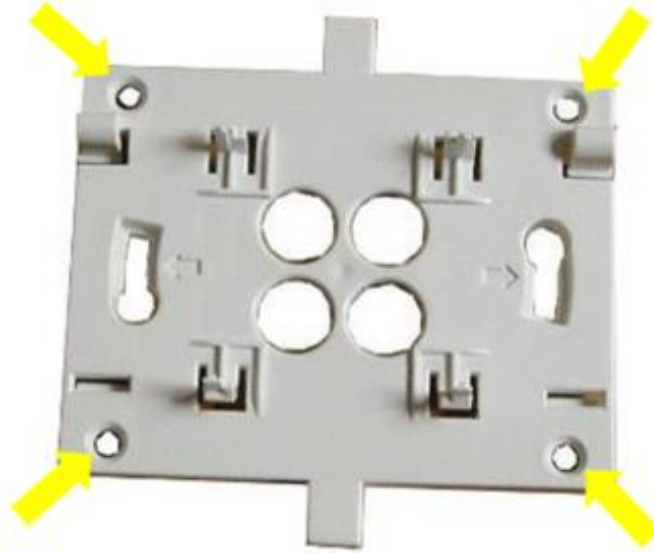

- Four additional positions are available to fix the support to the wall.

Wall support Installation on a wall

Step 3

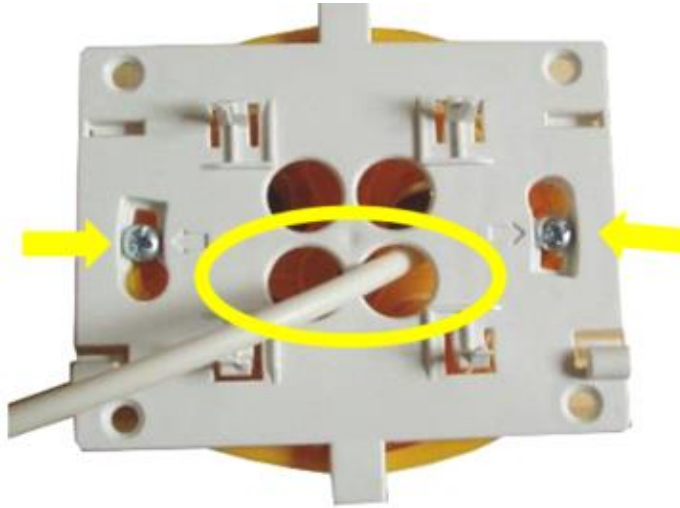

- In case of installation on an embedded wall socket, use the two screws already available.

NB: if the drop cable must enter from the inside of the wall support use one of the **two lower holes** for the cable.

Wall support Installation on a 35mm DIN rail

Step 4

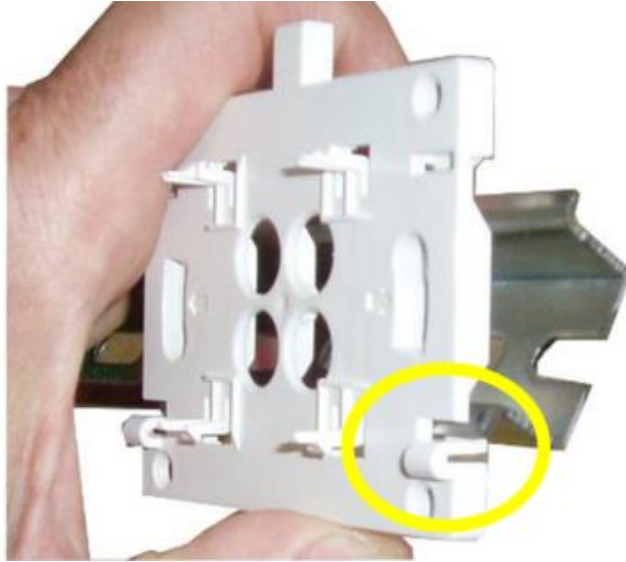

- If used inside a home hub, the wall support is mounted on a DIN rail.
- Insert the soft hooks on the DIN rail as shown.

Wall support Installation on a 35mm DIN rail

Step 5

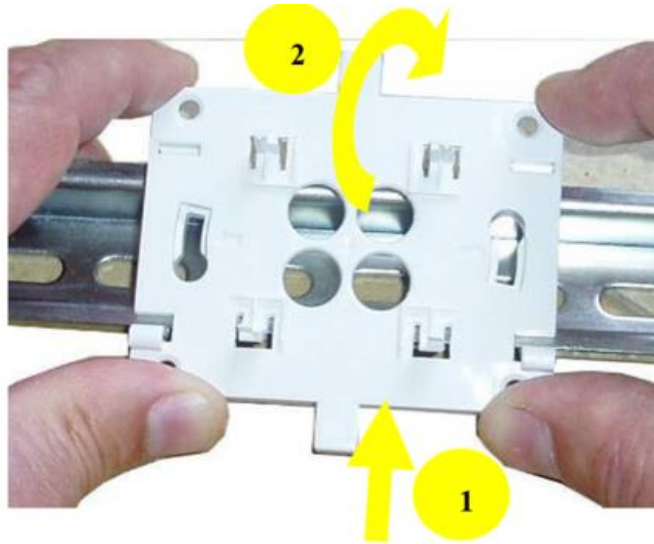

- By pushing up the wall support, rotate it toward the DIN rail and clips the top hooks.
- Check the support hold properly on the DIN rail.

Main cover opening

Step 6



- Remove the main cover from the CTBMK2 by pressing with a finger on the top side of the base.
- Lift the cover from the base.

Drop cable installation on a wall

An installation of the CTBMK2 horizontal with the cable entree entry on the bottom left side will be privileged

Step 7

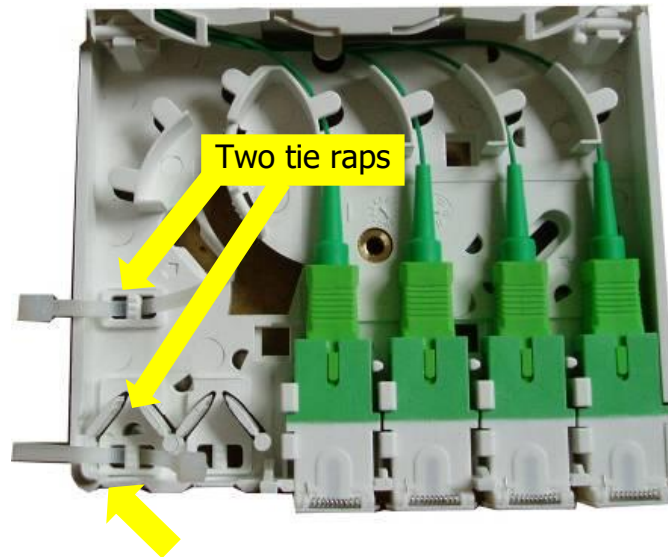

- Remove the square cut-out section on the front of the base using a pair of long nose pliers. Grip the section and pull forward to break off.
- Remove any burrs from the side walls and floor using a small file.
- Install the two tie raps used to fix the cable in positions.

Drop cable installation on a wall

Step 8

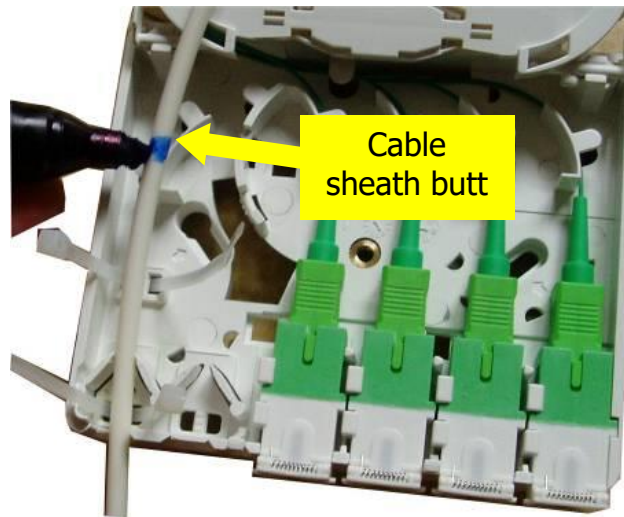

- Prepare the cable and mark the butt level with the beginning of the ramp of CTBMK2.
- Make a second mark 1 meter away from the first one and cut the cable.
- Remove the sheath and Kevlar yarns from the first butt mark.

Drop cable installation on a wall

Step 9

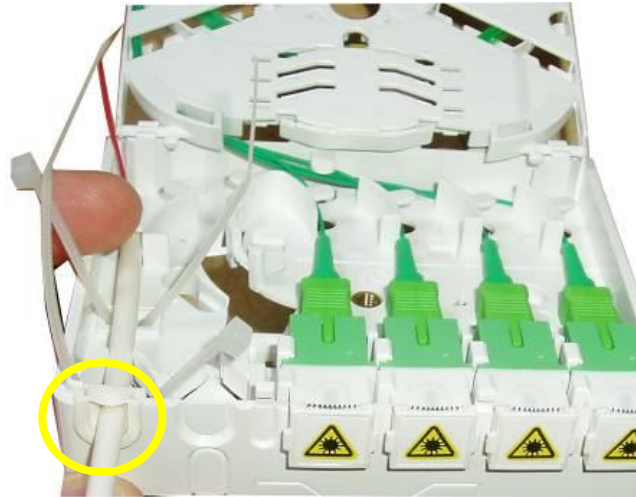

- Prepare then insert the membrane on the cable.
- Position the membrane on the base.

Drop cable installation on a wall

Step 10

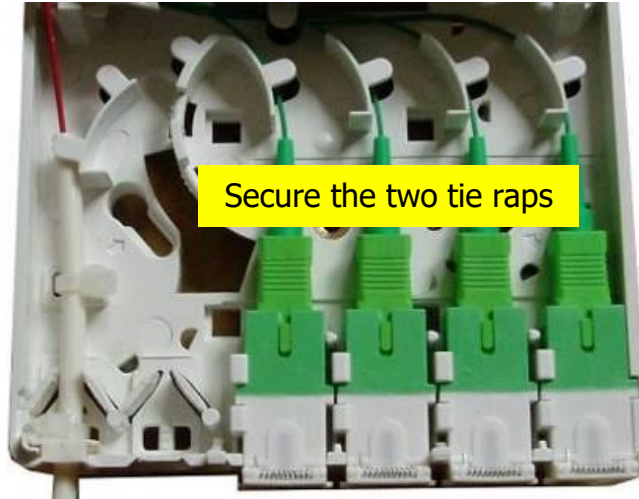

- Push the cable down into the grips and secure the cable ties.
- Cut the tie raps excess lengths.

Drop cable installation on a wall

Step 11

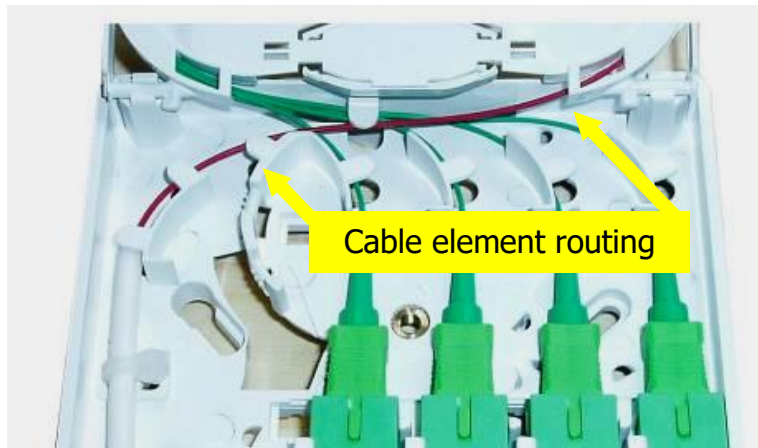

- Route the cable element underneath the tabs as shown and into the entry port of the splice tray.

Drop cable installation on a wall

Step 12

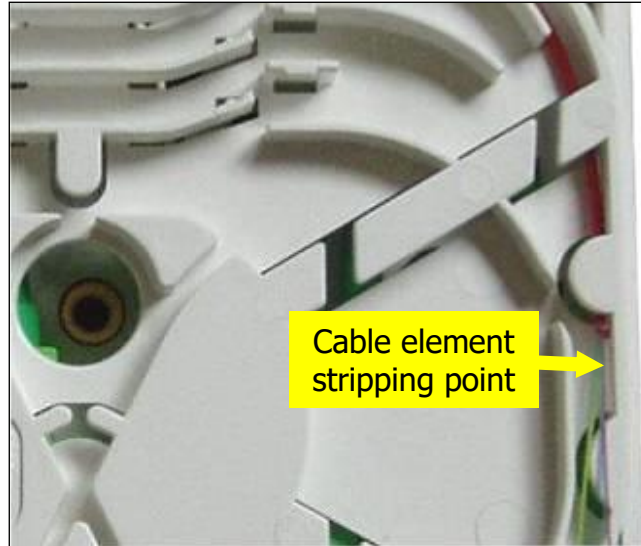

- Close the splice tray and strip the cable element sheath to expose the fibers.

Other possibility of installation of the drop cable

Step 13

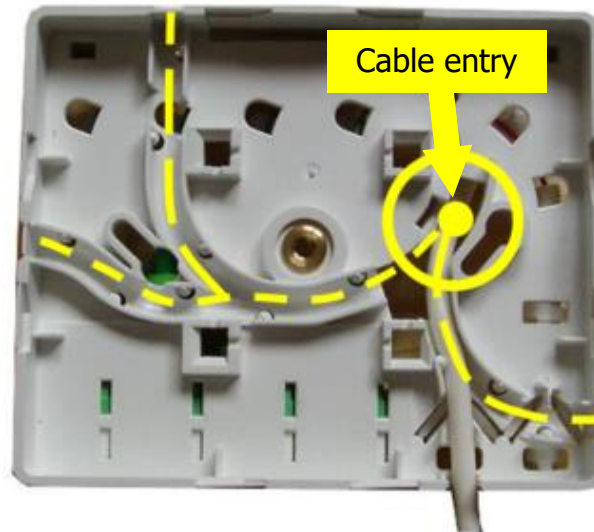

- It is possible to enter the base from the inside of it.
- Dedicated tracks can guide the cables from the four different sides of the base.
- Select the cable entry; Remove the square cut-out section on the front of the base using a pair of long nose pliers. Grip the section and pull forward to break off.
- Remove any burrs from the side walls and floor using a small file.

Other possibility of installation of the drop cable

Step 14

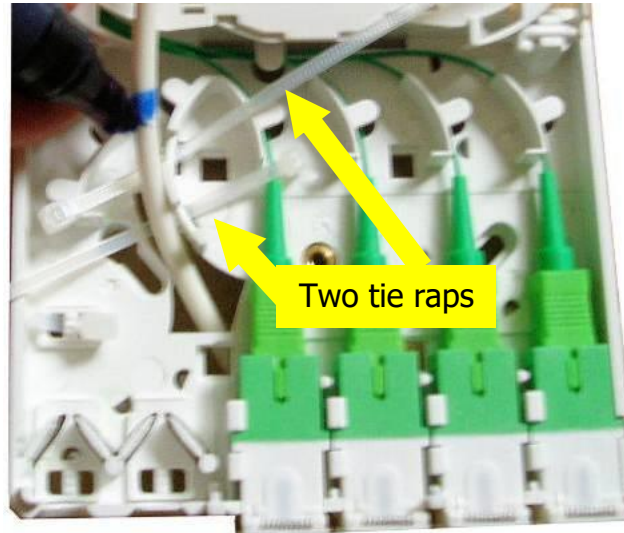

- Prepare the cable and mark the butt level with the end of the ramp of CTBMK2.
- Make a second mark 1 meter away from the first one and cut the cable.
- Remove the sheath and Kevlar yarns from the first butt mark.

Other possibility of installation of the drop cable

Step 15

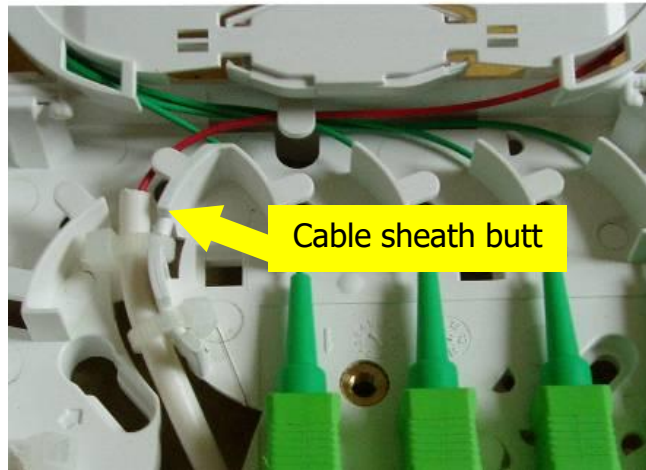

- Secure the cable ties and cut the excess lengths.
- Route the cable element underneath the tabs as shown and into the entry port of the splice tray.
- Go to **Step 12**.

Splicing Procedure

Step 16

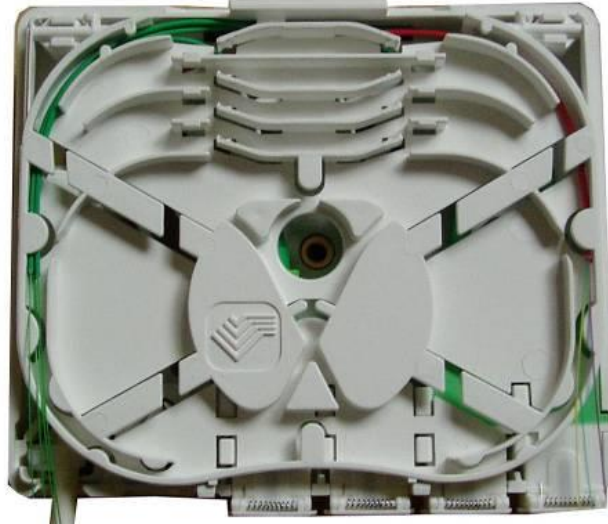

- Remove the pigtail fibers extra lengths from the tray.

Splicing Procedure

Step 17

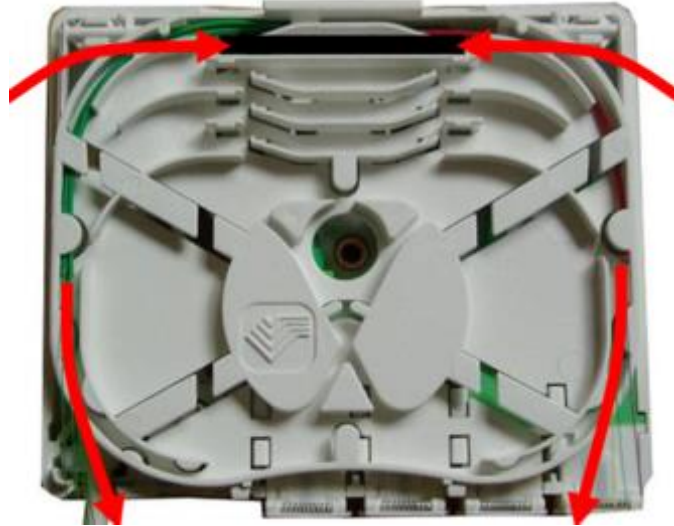

- Splice the first fiber using either a fusion or mechanical splice.
- Install the splice protector in the upper splice older.
- Repeat this step for all the fibers to be spliced.

Splicing Procedure

Step 18

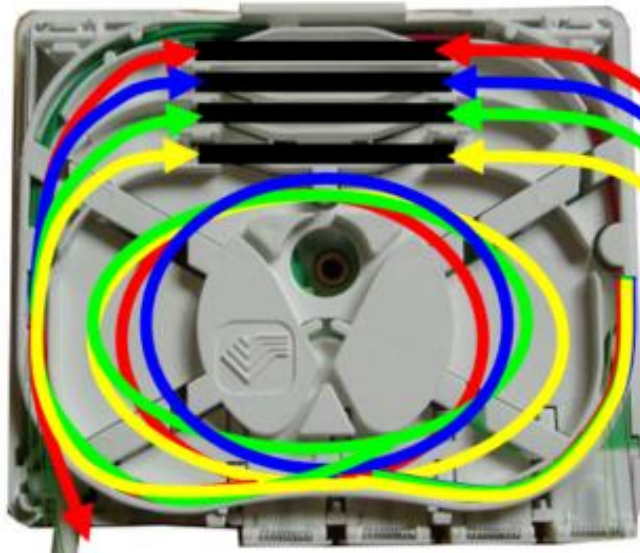

- Simultaneously coil the all the excess fibers lengths from one side of the splice protector in the central area of the tray.

Splicing Procedure

Step 19

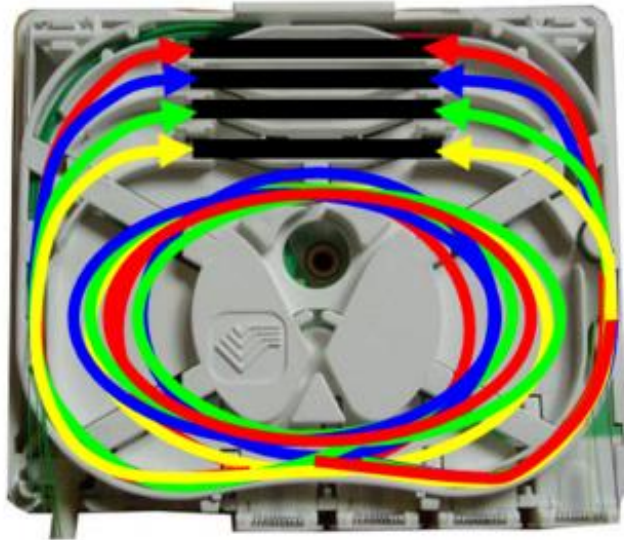

- Simultaneously coil the all the excess fibers lengths from the other side of the splice protector in the central area of the tray.
- Make sure all the fibers are below all the tabs.

Splicing Procedure

Step 20



- To close the CTBMK2, insert the main cover in the two clips on the lower side of the base.
- Rotate the main cover towards the base until it clips.

CTBMK2 installation

Step 21

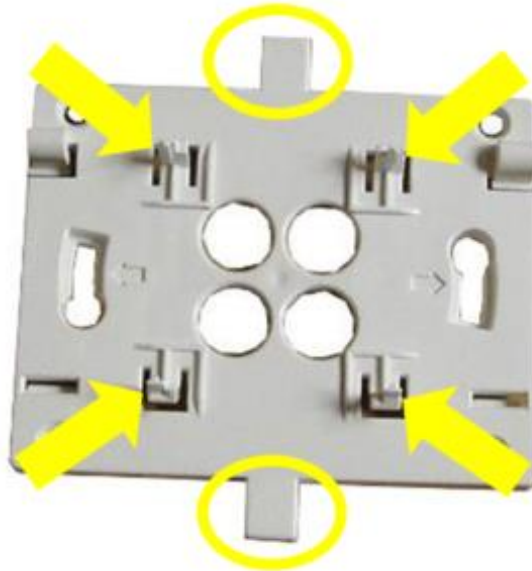

- Four clips on the wall support allows to clip the CTBMK2 in position.
- The two taps help to position the CTBMK2 against the wall support.

CTBMK2 installation

Step 22

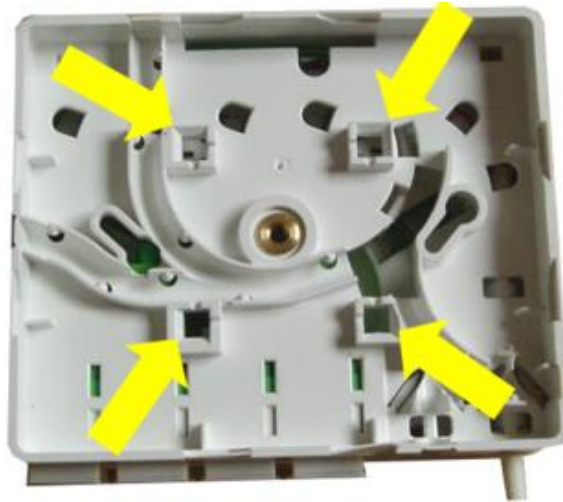

- On the base four holes are used to secure it to the wall support.

CTBMK2 installation

Step 23

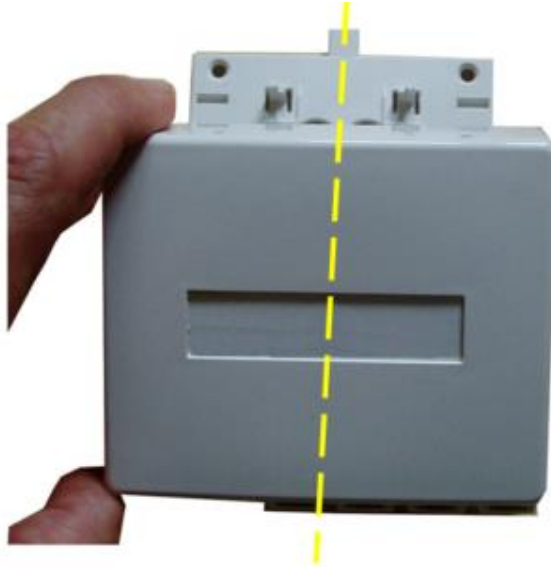

- Position the CTBMK2 slightly below the wall support by presenting the CTBMK2 is the correct vertical axis position.

CTBMK2 installation

Step 24



- Push the CTBMK2 up toward the wall support until it touches the tab.
- Rotate and push the CTBMK2 to clip it onto the wall support.
- Check the good positioning of the CTBMK2 to the wall support.

CTBMK2 installation

Step 25

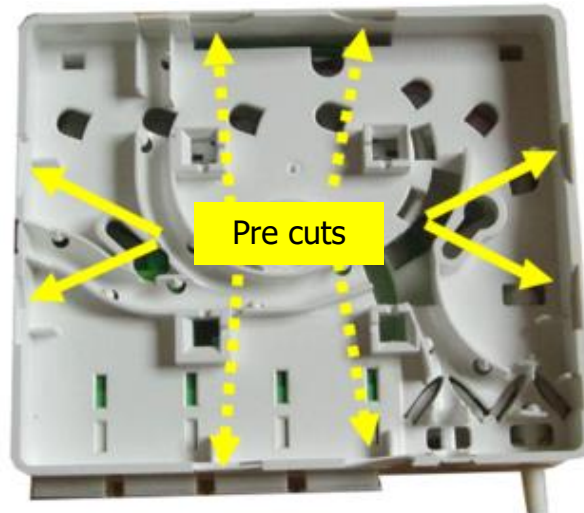

- In case the CTBMK2 must be installed on a DIN rail, remove the cut-out section of the base using a pair of long nose pliers. Grip the section and pull forward to break off.
- Remove any burrs from the side walls and floor using a small file.

CTBMK2 installation

Step 26



- Note the CTBMK2 can be installed vertically on the DIN rail.
- Beforehand, remove the cut-out section of the base.

CTBMK2 Labeling

Step 27

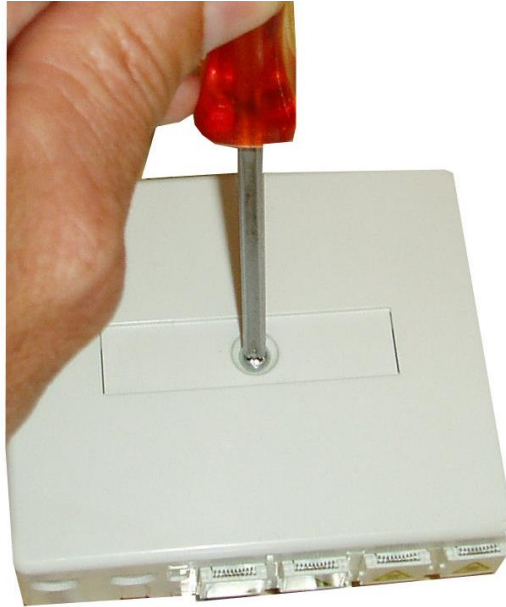

- The CTBMK2 is supplied with a screw to fix the main cover to the base.
- If necessary, fix it as shown above.

CTBMK2 Labeling

Step 28

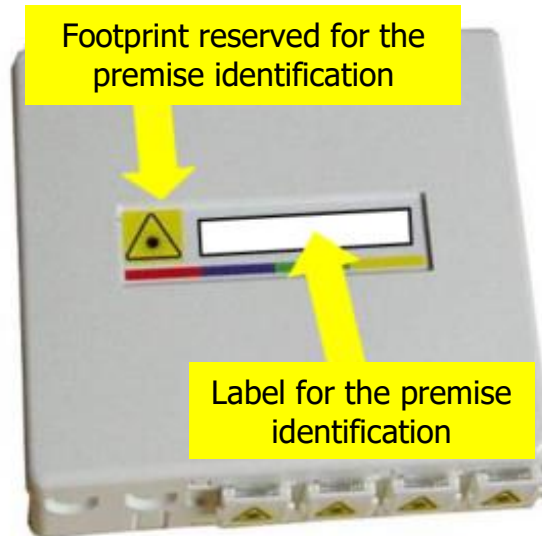

- CTBMK2 is supplied with a transparent label protection cover.
- An identification label can be installed in the dedicated area on the main cover.
- Transparent label protection cover can then be installed.

CTBMK2 Labeling

Step 29



- The shutters on the adapters can then be rotated open to plug in SC patch cords when required.

CTBMK2 removal

Step 30

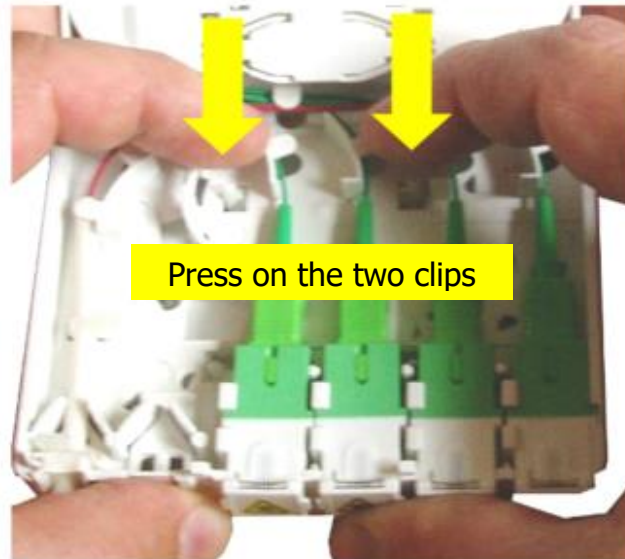

- Remove the main cover as described in **Step 6**.
- Lift the splice tray.
- With two fingers, push down the two top clips of the wall support, at the same time pivot the CTBMK2 forward to remove it from the wall support.